



VEILUX®

The Art of Surveillance

Operating Instruction & User's Guide

16/8 Channel Digital Video Recorder

SVR-1648DVD

SVR-824DVD

V.1.2

FCC Compliance Statement

Model Name:

SVR series (SVR-1648DVD, SVR824DVD)

This device complies with Part 15 of the FCC Rules. Operation is Subject to the following two conditions: (1) this device may not cause harmful interference, and (2) this device must accept any interference received, including interference that may cause undesired operations.

WARNING

Unauthorized reproduction of all or part of this manual is strictly prohibited.

The figures in this manual are for illustration purposes only (may differ from the actual product).

The specifications and design of the product are subject to change without prior notice for purposes of quality improvement.

CAUTIONS

To get the best use out of the product, be sure to read the cautions before using the product. For safety, please take note of the following.

➤ Instructions before using the product

- 1 To prevent electric shock when installing, moving, or opening the DVR and peripheral devices, connect and disconnect the cables as instructed. All cables must be connected to grounded power outlets.
- 2 If the product is installed near a power outlet, make sure it can be unplugged easily.
- 3 Do not use the DVR in water or in wet places.
- 4 Keep the plastic packing materials used for the DVR or other peripheral devices out of reach of children (may cause suffocation).

➤ Installation Environment of the DVR

- 1 Maintain the following conditions: operating temperature of 5°C ~ 40°C; operating humidity of 10% ~ 80%.
- 2 Install the DVR in a safe place that is free from external vibration.
- 3 Install the DVR in a well-ventilated place.
- 4 To protect the hard disk from data loss and breakdown, install the DVR away from magnetic materials.
- 5 When using a rack other than the standard one, use a separate table with sufficient spacing, i.e., 60cm from the floor, 50cm from the ceiling, and 20cm from the side and back walls and other objects.



➤ Safety Notes on the DVR



- 1 When installing additional boards and HDD, separate the power cable and turn OFF power supplied to the DVR completely.
- 2 Keep the product away from heat-generating devices such as heaters.
- 3 Do not use a damaged power cord.
- 4 To prevent problems due to magnetic interference and electric surge, use only grounded cables and power outlets.
- 5 If the power cord is connected, do not touch the power unit. If the power cord is connected, electric current is still flowing internally even after the switch is turned OFF.
- 6 Do not place a heavy object on top of the product.
- 7 Do not drop a conductive object in the ventilation holes.
- 8 Allot sufficient space for system cabling.
- 9 Use only the parts indicated in the manual. Do not disassemble, repair, or modify the product without permission.
- 10 Incorrect system setup may cause malfunction.
- 11 Shut down the system normally as instructed in the manual.

➤ Safety Notes on the Lithium Battery

- 1 Replace lithium batteries as instructed to avoid danger.
- 2 Dispose used lithium batteries properly.

【Warnings and Cautions are indicated as follows.】

	Possible injury or product damage.
	Risk of minor injury or product damage.

	Cautions for the usage of the product.
	Information for the usage of the product.

CONTENTS

Chapter 1. Introduction	6
1 - 1 SVR series Major Features	7
1 - 3 About the Product	8
1 - 5 Components	8
Chapter 2. Installation and Connection	8
1 - 6 SVR series Name and Features of Each Part	8
1 - 6 - 1 SVR Series Front Panel	9
1 - 6 - 3 SVR-824DVD Channel Rear Panel	9
1 - 6 - 4 SVR-1648DVD Channel Rear Panel	9
1 - 8 Installation and Connection	11
1 - 8 - 1 Basic Connection	11
1 - 8 - 2 Connection of Other Devices	12
Chapter 3. Operation and Setup Tools	13
1 - 9 SVR series Front Panel Button	14
1 - 1 0 SVR series Remote Controller	15
1 - 1 3 Mouse	17
Chapter 4. DVR Operation Setup	17
1 - 1 4 SVR series Storage Installation	17
1 - 1 6 Power ON.	19
1 - 1 7 Storage Setup	20
1 - 1 8 Recording Setup	22
1 - 1 9 Date/Time Setup	22
1 - 2 0 Camera / TV Setup	22
1 - 2 1 External Device Setup	22
1 - 2 2 Recording View	22
1 - 2 3 Backup	22
1 - 2 4 DVR Information View	22
Chapter 5. System Operation	22
1 - 2 5 Starting and Exiting the System	22
1 - 2 5 - 1 Starting the System	22

1-2 5-2 Exiting the System	22
1-2 6 Monitoring	23
1-2 6-1 Screen Division and Auto Sequence	23
1-2 6-2 Channel Grouping	24
1-2 6-3 Spot	24
1-2 6-4 Menu in Monitoring Mode	24
1-2 7 System Login	24
1-2 7-1 User Account and Authorization	24
1-2 7-2 Login	25
1-2 7-3 Logout	25
1-2 8 Audio Recording and Playback	25
1-2 8-1 Audio Recording Setup	25
1-2 8-2 Audio Live	25
1-2 9 System Information View and Display Setup Change	25
1-2 9-2 System Information	27
1-2 9-3 Camera Selection for Screen Setup	28
1-2 9-4 Screen Brightness	28
1-2 9-5 Contrast	28
1-2 9-6 Camera Adjustment	28
1-2 9-7 Camera Title Shown/Hidden	29
1-2 9-8 Screen Border Adjustment	29
1-2 9-9 Screen saver	30
1-2 9-10 Spot & Main display repeating	30
1-2 9-11 TV OUT Adjustment	30
1-3 0 Spot Control	31
1-3 1 Relay Out	31
1-3 2 Search	32
1-3 2-1 Search Mode	32
1-3 2-2 Playback Menu	32
1-3 3 Calendar Search	33
1-3 3-1 Search Mode	33
1-3 3-2 Year/Month/Day Selection	33
1-3 3-3 Directory Count	33
1-3 3-4 Event	33
1-3 3-5 Multi-Channel Search	33
1-3 3-6 Multi-Time Search	34
1-3 3-7 Multi-Day Search	34
1-3 4 Playback	34
1-3 4-1 Playback and Playback Speed Control	35
1-3 4-2 Smart Search	36
1-3 4-3 Calendar Search	37
1-3 4-4 MULTI TIME	37
1-3 4-5 MULTI DAY	37
1-3 4-6 MULTI CHANNEL	37
1-3 4-7 Event	37

1-3 4-8 Audio	37
1-3 4-9 Backup	37
1-3 4-1 0 De-Interlace	37
1-3 4-1 1 Display Mode	37
1-3 4-1 2 Status Bar	37
1-3 5 Log Viewer	37
1-3 5-1 Log Type	38
1-3 5-2 System Log Viewer	39
1-3 6 Recording	39
1-3 6-1 Recording Types	39
1-3 6-2 Recording Setup	40
1-3 6-3 Recording Status View	40
1-3 7 Backup	40
1-3 7-1 Backup in Real-time Monitoring Mode	40
1-3 7-2 Backup in Search Mode	41
1-3 7-3 Backup in Log Mode	41
1-3 7-4 Backup in Playback Mode.....	41
1-3 7-5 Common Backup Procedure	41
1-3 8 Log Backup	42
1-3 9 Setup Backup	43
1-4 0 NAS Backup	44
1-4 1 Snapshot	44
1-4 2 PTZ Camera Control	44
1-4 2-1 Conditions for Using the PTZ	44
1-4 2-2 PTZ Mode	45
1-4 2-3 PTZ Control	46
Chapter 6. Setup	47
1-4 3 Time	47
1-4 3-1 Time Sever	48
1-4 3-2 Date and Time	49
1-4 3-3 Standard Time Zone	50
1-4 3-4 scheduled rebooting	51
1-4 4 definition	51
1-4 4-1 camera	52
1-4 4-2 PTZ	52
1-4 4-3 Event Source	54
1-4 4-4 relay	57
1-4 5 Action	58
1-4 5-1 schedule (schedule1 - schedule4)	58
1-4 5-2 event	58
1-4 5-3 recording	59
1-4 5-4 Alarm	61
1-4 5-5 Duration	62
1-4 5-6 log	63
1-4 6 Schedule	63
1-4 6-1 Enter to Schedule Menu	64

1-4 6-2 Schedule Setup	64
1-4 7 Storage	65
1-4 7-1 Max. Recording Days	66
1-4 7-2 HDD Overwrite	66
1-4 8 Network	70
1-4 8-1 Ethernet	70
1-4 8-2 DDNS	71
1-4 8-3 Port	72
1-4 8-4 E-mail	73
1-4 8-5 Bandwidth	74
1-4 9 Callback	75
1-5 0 System	75
1-5 0-1 System Menu	76
1-5 0-2 DVR Name	76
1-5 0-3 ID for Remote Controller	76
1-5 0-4 ID For Keyboard Controller	77
1-5 0-5 User Registration	77
1-5 0-6 Admin. Password	78
1-5 0-7 Upgrade	78
1-5 0-8 Factory Default	80
1-5 0-9 RS232C Port	80
1-5 0-1 0 Alarm	80
1-5 0-1 1 Alarm Setup	81
1-5 0-1 2 Menu Time Out	81
1-5 0-1 3 Language	82
A/P/P/E/N/D/I/X	83
(1) Recommended HDD Specification	83
(2) Recommended PTZ Camera Protocol	83
(3) Recommended USB2.0 Device	83

Figure List

[Figure 2-1. SVR-1648DVD Basic Connection and Device Connection]	11
[Figure 2-3. Terminal Block TB1]	12
[Figure 2-4. Terminal Block TB1 Description]	13
[Figure 4-5. Menu Window]	20
[Figure 4-6. Storage Device New Tab Window]	20
[Figure 4-7. Storage Device New Tab Menu Window].....	21
[Figure 4-8. Storage Device Save Tab Window]	21
[Figure 5-9. Login Window]	25
[Figure 5-10. Recording Status Window]	26
[Figure 5-11. Product Information Window]	27
[Figure 5-12. Camera/TV Setup Window]	28
[Figure 5-13. Display Setup Window]	29
[Figure 5-14. Spot Control Window]	31
[Figure 5-15. Relay Control Window].....	31
[Figure 5-16. Playback Menu Window]	32
[Figure 5-17. Search Window]	33
[Figure 5-18. Playback Screen]	35
[Figure 5-19. Playback Status and Control Window]	35
[Figure 5-20. Playback Menu]	36
[Figure 5-21. Smart Search Motion Detection Window]	36
[Figure 5-22. Display Mode]	37
[Figure 5-23. Log Viewer]	38
[Figure 5-24. Move to the log list of the certain time zone]	39
[Figure 5-25. Backup Window]	41
[Figure 5-26. NAS Backup Window]	44
[Figure 5-27. PTZ Control Window (Max. Mode (Left) / Min. Mode (Right))]	45
[Figure 5-28. PTZ Mode Initial Screen].....	46
[Figure 6-29. Time Server]	48
[Figure 6-30. Date and Time]	49
[Figure 6-31. Standard Time Zone]	50
[Figure 6-32. Schedule Window]	64
[Figure 6-33. Holiday Registration Window]	65
[Figure 6-34. Storage Window (Local)]	66
[Figure 6-35. Storage Offline]	69
[Figure 6-36. Storage Format]	69
[Figure 6-37. Storage Formatting Message in progress]	70
[Figure 6-38. Setup Network Window]	71
[Figure 6-39. DDNS Window]	72
[Figure 6-40. Port Window]	73
[Figure 6-41. E-mail Window]	74
[Figure 6-42. Bandwidth Window]	75
[Figure 6-43. System Setup Window]	76
[Figure 6-44. User Authorization Setup Window]	78
[Figure 6-45. Firmware Upgrade File List Window]	79
[Figure 6-46. Firmware Upgrade Progressing Window].....	80
[Figure 6-47. Alarm].....	81
[Figure 6-48. Language Selection Window]	82

Chapter 1. Introduction

1 - 1 SVR series Major Features

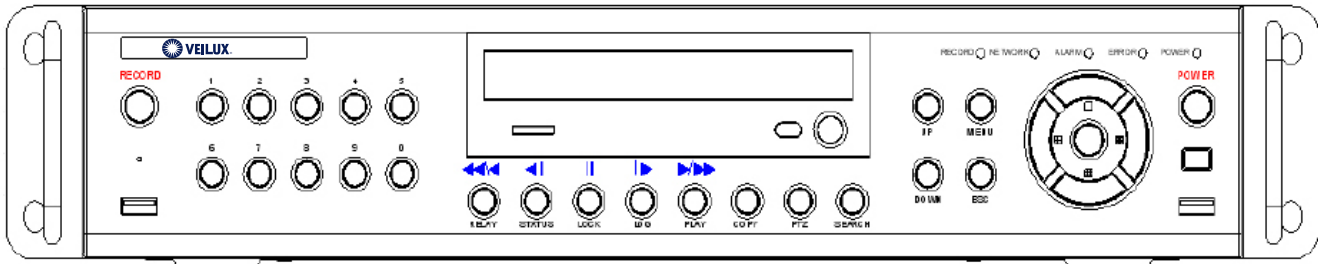

	SVR-1648DVD	SVR-824DVD
System	Reliable Standalone DVR	
Channel & Frame Rate	16Ch - 480/480	8ch - 240/240
OS	Embedded Linux - Built in Flash Memory	
Video Input	16 BNC	8 BNC
Video Output	Monitor	1 BNC, 1 VGA
	Loop	16 BNC
	Spot	1 BNC
Audio Input	Line Input: 16 RCA	Line Input: 8 RCA
Audio Output	Line Output: 1 RCA	
Compression Format	[Video : Standard H.264] / [Audio : G.723]	
Recording Speed	Max. 480(400)fps	Max. 240(200)fps
Recording Resolution	Max. 704 x 480(576)	
Recording mode	Automatic, Continuous, Manual, Events(Sensor and Motion, Sound)/Schedule Recording	
Storage	[Internal : Max. 3HDD, Max. 6TB]	
Video Output Resolution	LCD : SXGA(1280 x 1024), TV : SDTV(720 x 480/576)	
Sensor Input	16 Sensors [1ea	8 Sensors [1ea
Relay/TTL Output	NC/NO][3ea TTL Out]	NC/NO][1ea TTL Out]
Backup & Copy Access	DVD-RW, USB2.0, Network	
Network Access	Various Network Interface (Ethernet 10/100/1000, ADSL, Cable modem)	
PTZ Access	RS485	
Internal HDD / Internal ODD	SATA HDD Max. 3ea / SATA Type DVD	
System Operation & Adjustment	Front Button, Mouse, IR Remote Controller, Keyboard Controller, Network	
System Upgrade	USB2.0 Memory Stick, Network	
Network	System Automation (Controlled by CMS)	
	NTP Supported	
	CMS / Monitoring by Web Browser / PDA	
Others	17 Languages Supported, Automatic E-mail	
	Power [12V/5A] / Max. Power Consumption[40W] / Operating Temperature[5-40℃] Weight without HDD[4kg] / Dimension[430*86*270mm]	

Recording mode	Auto, Continuous, Manual, Event(sensor, motion and sound)/Schedule Recording
Storage	[Internal : Max. 2HDD, Max. 4TB]
Video Output Resolution	LCD : SXGA(1280 x 1024), TV : SDTV(720 x 480/576)
Sensor Input Relay Output	4 Sensors / [1ea NC/NO]
Backup & Copy Access	USB2.0, Network
Network Access	Various Network Interface (Ethernet 10/100, ADSL, Cable modem)
PTZ Access	RS485
Internal HDD	SATA HDD 2ea
System Operation & Adjustment	Front Button, Mouse, IR Remote Controller, Keyboard Controller, Network
System Upgrade	USB2.0 memory stick, Network
Network	System Automation (Controlled by CMS)
	NTP supported
	CMS / Monitoring by Web Browser / PDA
Others	17 Languages Supported Automatic E-mail Transmission
	Power [12V/5A] / Max. Power Consumption[40W] / Operating Temperature[5-40℃] Weight without HDD[3kg] / Dimension[340*58*300mm]

1 - 3 About the Product

As a digital image monitoring equipment that can display images inputted from up to 16/8 cameras, **SVR - Series** digitally records high-quality images using various video recording modes and displays them as clean quality images.

For users' convenience, front panel button, remote controller, and mouse are provided. Powerful network functions including remote monitoring and remote system setup modification are also supported. The maximum recording frame rate is 480(400)/240(200)fps.

1 - 5 Components

After unpacking the product, check whether the following accessories are included.

- Remote Controller
- CD (CMS, CMS Manual, PDA Viewer software)
- AAA 1.5V Batteries 2ea
- Adapter 12VDC
- User Manual
- Rack Mounting Handle

Chapter 2. Installation and Connection

1 - 6 SVR series Name and Features of Each Part

The front panel of **SVR-series** features an easy-to use button; various interfaces are located on the rear part. They can easily be mounted on a standard rack using the mounting handles (Left/Right).

1-6-1 SVR Series Front Panel

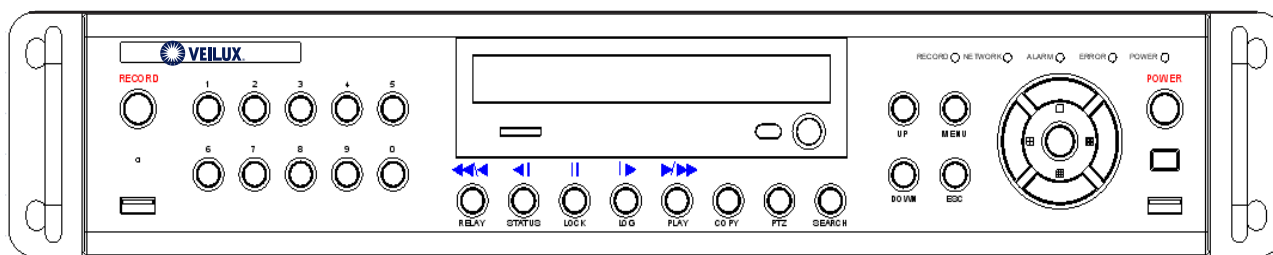

1-6-3 SVR-824DVD Channel Rear Panel

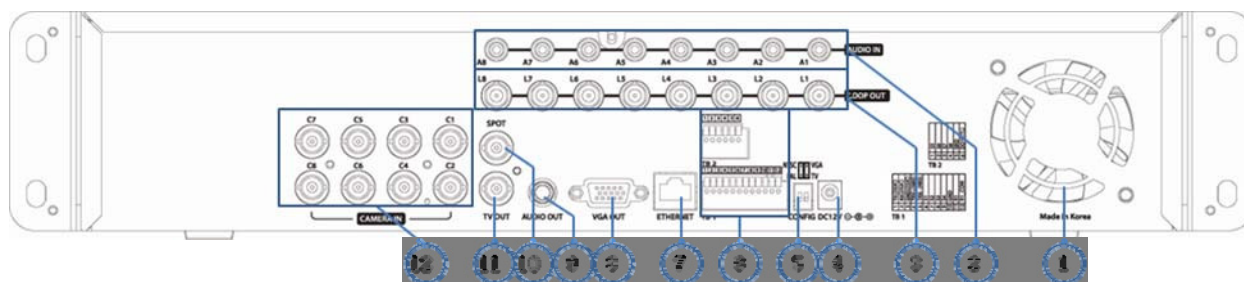

1-6-4 SVR-1648DVD Channel Rear Panel

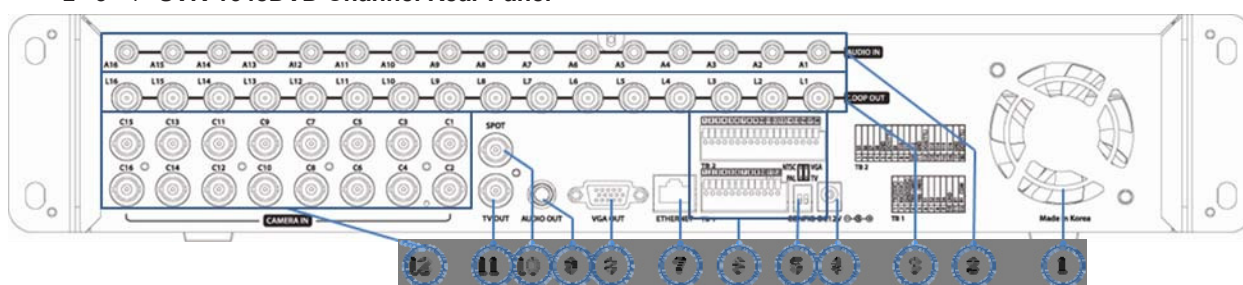

No.	Name	Function	Type
1	FAN	Cooling system	
2	AUDIO IN	Audio Input Connection(Line Only Input)	RCA
3	LOOP OUT	Video Signal loop-back Output Connection	BNC
4	DC IN	Power cable connection to the body	
5	NTSC/PAL VGA/TV	Select the video input format Select the video output format	DA-2
6	RS485 DIO	PTZ Camera Control Connection Sensor/ Relay Connection	Terminal Block
7	ETHERNET	Network Connection(ADSL, Cable Modem, Ethernet 10/100 Base-T)	RJ-45
8	VGA-OUT	VGA Monitor or LCD Monitor Connection	D-SUB 15P
9	AUDIO OUT	Audio Output Connection(Line Only Output)	RCA
10	SPOT	CCTV monitor connection to output image from the channel generating an event signal (Full Screen)	BNC
11	TV	CCTV Monitor Connection(Divided Screen)	BNC
12	CAMERA IN	Video Camera Connection	BNC

5	RS485 DIO	PTZ Camera Control Connection Sensor / Relay Connection	Terminal Block
6	Ethernet	Network Connection (ADSL, Cable Modem, Ethernet 10/100/1000 Base-T)	RJ-45
7	VGA-OUT	VGA Monitor or LCD Monitor Connection	D-SUB 15P
8	AUDIO OUT	Audio Output Connection(Line Only Output)	RCA
9	TV	CCTV Monitor Connection(Divided Screen)	BNC
10	CAMERA IN	Video Camera Connection	BNC

1 - 8 Installation and Connection

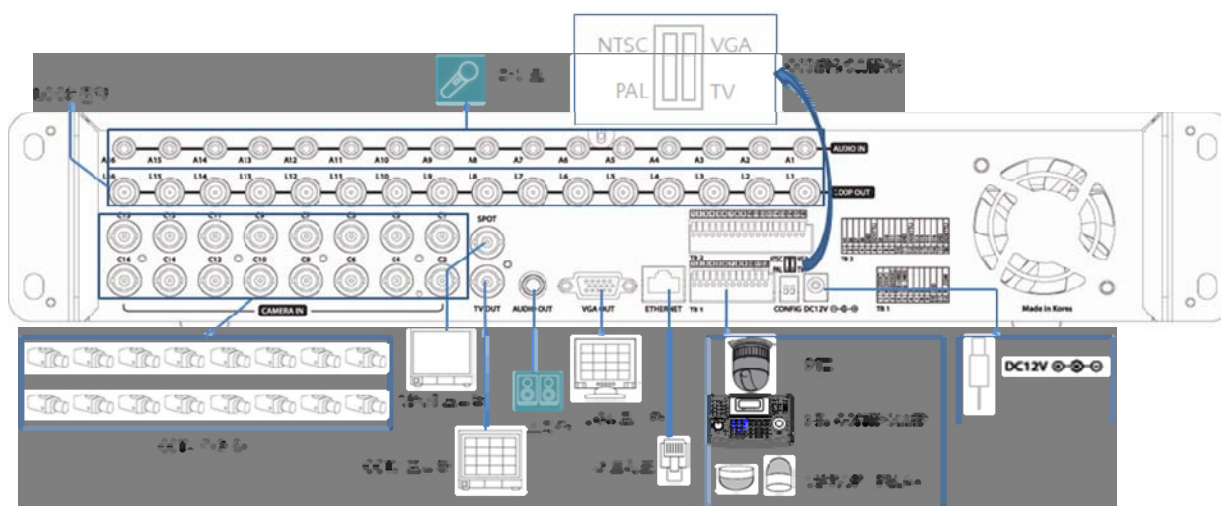

[Figure 2-1. SVR-1648DVD Basic Connection and Device Connection]

	Connected Device	DVR Terminal
1	CCTV camera	Rear Panel Video Input
2	CCTV monitor	Rear Panel TV

3	VGA Monitor / LCD Monitor	Rear Panel VGA-OUT
4	Mouse	Front Panel USB
5	CONFIG SWITCH	Rear Panel NTSC/PAL or VGA/TV Setup

Refer to a further description of CONFIG SWITCH below.

1. The input video type must be either NTSC or PAL; these two types must not be used together.
2. Select the input video format (NTSC/PAL) using the CONFIG switch on the rear side of the product.
3. Select the output monitor type (VGA/TV) using the CONFIG switch on the rear side of the product.
4. CONFIG SWITCH



- 1) VGA Mode
Resolution of VGA Monitor is **SXGA** (1280*1024) and CCTV Monitor output is supported.
- 2) TV Mode
CCTV Monitor output is supported but No VGA mode.

Connect the PTZ controller cable, audio input/output, network, and sensors as shown below.

	Connecting Device	DVR Terminal
1	SPOT Monitor(CCTV Monitor)	Rear Panel SPOT
2	Mike / Speaker	Rear Panel Audio Input / Audio Output
3	LAN Cable	Rear Panel Ethernet
4	PTZ Camera	Rear Panel Terminal Block
5	Sensor / Relay / TTL OUTPUT	Rear Panel Terminal Block)
6	Key controller	Rear Panel Terminal Block

1) SPOT Monitor

Connect Spot Monitor to the rear SPOT terminal.

2) Audio Input/Output

Depending on models[16ch/8ch], each of the models supports [16/8] line input and 1 line output.

3) Terminal Block



[Figure 2-3. Terminal Block TB1]

1	TX
2	RX
3	GND
4	TRXD+
5	TRXD-
6	S1
7	S2
8	S3
9	S4
10	GND
11	R1
12	R1_COM

TB 1

[Figure 2-4. Terminal Block TB1 Description]

Terminal Blocks(TB1, TB2) in the rear of the product are for connections of PTZ / Sensor / Relay / TTL Connection. Terminal Blocks may not be available depending on the model.

4) PTZ Camera/Keyboard Controller

Connect PTZ control cable; TRX+, TRX- and GND to Terminal Block(TB1);No.4 TRXD+, No.5 TRXD- and No.10 GND in the rear of DVR. In case of HV-4U, connect PTZ control cable; TRX+ and TRX- to Terminal Block No.1 TRXD+ andNo.2 TRXD- directly. You may refer to APPENDIX for supported PTZ cameras in this manual. Keyboard controller has the same connection as PTZ camera.



PTZ Camera may not be working properly if GND is not connected.

5) Sensor/Relay /TTL

Sensor and Relay are connected to Terminal Block(TB1) and Terminal Block(TB2) directly depending on the model.

(1) Sensor Connection

- ① Connect Sensor to Terminal Block (TB1) and S1 ~ S16 of Terminal Block (TB2) depending on the model.
- ② Each input terminal may be connected regardless of the channel number.

	<p>Sensor types include Normal Close (NC) and Normal Open (NO). For more information on setup by sensor type, refer to {Menu} {Setup} {Definition} {Event Source} {Sensor Type}.</p> <p>NC(Normal Close) : Normally closed; opens when a signal is received.</p> <p>NO(Normal Open) : Normally open; closes when a signal is received.</p>
--	---

(2) Relay Connection

- ① Outputs alarm signals to external devices such as LED and siren by relaying them to these external devices.
- ② Connect Relay to R1 of Terminal Block (TB1).

	<p>Relay types include Normal Close (NC) and Normal Open (NO). For more information on setup by sensor type, refer to {Menu} {Setup} {Definition} {Relay} {Relay type}.</p> <p>NC(Normal Close) : Normally closed; opens when a signal is received.</p> <p>NO(Normal Open) : Normally open; closes when a signal is received.</p>
--	--

(3) TTL Connection

- ① This is for the external alarm devices such as an alarm and a siren that are supplied with voltage level LOW (0V) or HIGH (5V).
- ② Connect TTL device to DO1 (TTL) / DO2 (TTL) / DO3 (TTL) of Terminal Block (TB2).



The external alarm device may require the power supply depending on its type.

Chapter 3. Operation and Setup Tools

SVR series is operated by Front Button, Remote Controller and Mouse.

1-9 SVR series Front Panel Button

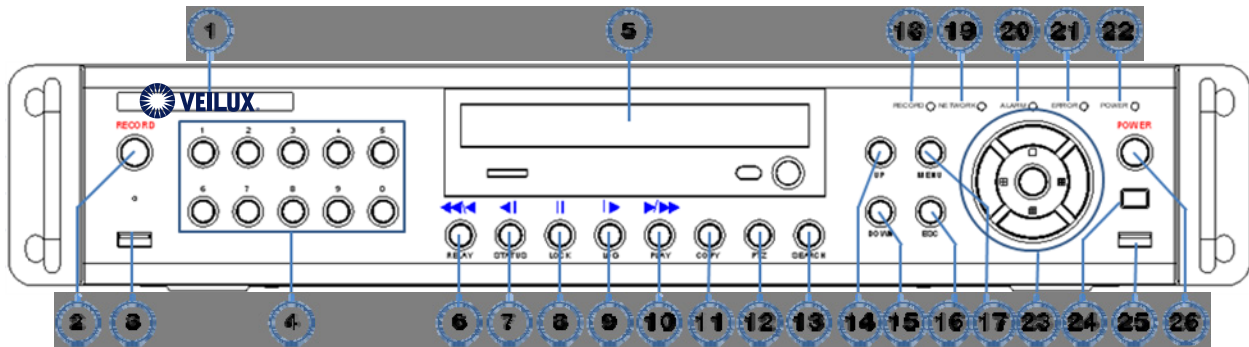

No	Name	Feature
1	LABEL	Veilux
2	ODD	CD-RW and DVD-RW
3	EJECT	CD and DVD Media
4	REVERSE PLAY / FAST REVERSE & RELAY	Backward Playback/Rewind (in Playback mode) Relay Control (in Monitoring mode)
5	REVERSE FRAME BY FRAME & STATUS	Backward Playback Frame by Frame (in Playback mode) View System Configuration (in Monitoring mode).
6	PAUSE & LOCK	Lock (in Monitoring mode)
7	FORWARD FRAME BY FRAME & LOG	Playback Frame by Frame (in Playback mode) System Log View(in Monitoring mode)
8	FORWARD PLAY / FAST FORWARD & PLAY	Playback/Fast Forward (in Playback mode) Play back (in Monitoring mode)
9	ESC	Exit the current menu or selects the upper menu.
10	USB Port	Connection port to the USB mouse and USB memory stick
11	POWER	Turn the system power ON or OFF.
12	POWER LED	Power LED On/Off
13	MOVE & DISPLAY & Select	Moves from one category to another or changes the display mode.
14	MENU	Various Modes
15	SEARCH	Search Recorded Images.
16	BACKUP	Save recorded images at other media.
17	CAPTURE	Capture a playing image into USB.
18	PTZ	Change Pan/Tilt/Zoom Mode.
19	SPOT	SPOT Control
20	NUMBER	Channel Selection and Number Input
21	ERROR LED	Blue LED turned on upon fan defect or recording interruption.
22	ALARM LED	Blue LED turned on upon the occurrence of event or motion.
23	NETWORK LED	Blue LED turned ON during remote access.
24	RECORD LED	Blue LED turned on upon HDD operation.

1-10 SVR series Remote Controller

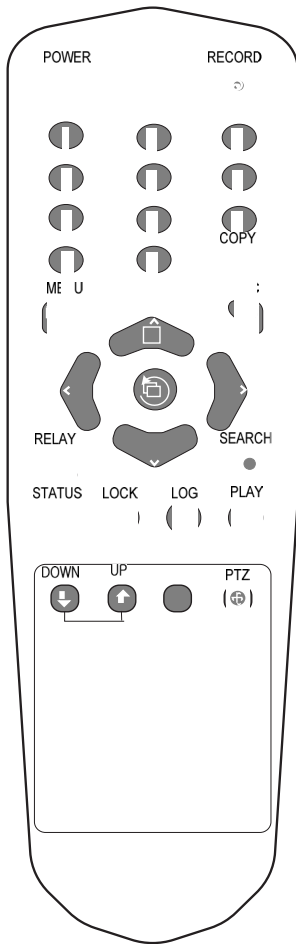

A) Basic Control Button

	POWER	Turn the system power ON or OFF.
	RECORD	Record all channels or stops recording all channels.
	NUMBER	Enable input of numeric data.
	ID	Set up the remote controller ID.

B) System operation and setup buttons

	MENU	Data, Schedule, System Set up
	ESC	Exit the current menu or select the upper menu.
	SEARCH	Search recorded images.
	SELECT	Select the category or execute automatic screen conversion.
	COPY	Copy Recorded Video.
	PTZ	Shift to PTZ camera control mode.
	MOVE	Move from one category to another or change the display mode.
	UP/ DOWN	Speed and Volume Control

C) Search Button (Playback mode)

	Play / Fast Forward	Play/Fast-forward
	Frame by Frame	Play frame by frame
	Pause	Pause
	Reverse Frame by Frame	Reverse play frame by frame
	Reverse Play / Fast Reverse	Reverse play/ Rewind

D) Buttons for other features (Monitoring mode)

	PLAY	Play the recorded images.
	LOG	Enable viewing the system log list.

LOCK ()	LOCK	Locking the system
STATUS ()	STATUS	View system information and changes the display setup.
RELAY ()	RELAY	View Relay Status and Manual Operation.

※ Setting up the remote controller ID

Example) When the remote controller ID is set to 1.



Press the {ID} button, enter a two-digit remote controller ID, and press the {ID} button again.



To control all DVRs with different IDs, set the remote controller ID to 999.

No.	Name	Feature
1	LABEL	Brand Name and Model Name
2	USB Port	USB Mouse, USB Memory Stick Connection Port
3	Reverse Play	Backward Playback/Rewind (in Playback mode)
4	Reverse Frame by Frame	Backward Playback Frame by Frame (in Playback mode)
5	PAUSE	Pause (in Playback mode)
6	Frame by Frame	Playback Frame by Frame (in Playback mode)
7	PLAY	Playback/Fast Forward (in Playback mode)
8	MENU	Various Modes
9	ESC	Exit the current menu or selects the upper menu.
10	MOVE & DISPLAY & Select	Move from one category to another or changes the display mode.
11	POWER	Power On/Off
12	POWER LED	LED indicating Power On/Off
13	RECORD LED	Blue LED turned on upon HDD operation.

1 - 1 3 Mouse

The USB mouse can be used to operate the system. The mouse pointer as below photo will be shown if a mouse is connected to USB terminal at front panel.

	Mouse Control supports features are shown below.	
	Click on the right button	Monitoring Mode / Move from Play Mode to Monitoring Menu / Pop up or remove Play Menu. Show sub-folder of the certain Menu window.
	Click on the left button Double click on the left button Click and drag the left button	Select Menu. Select Menu. Move a certain window.

Chapter 4. DVR Operation Setup

1 - 1 4 SVR series Storage Installation

※ The recommended HDD specification are shown below.

	Type	Size	Capacity	Buffer	RPM
	SATA I, II	3.5" 1, 2 Flat	Up to 2TB	over 8MB	over 7200

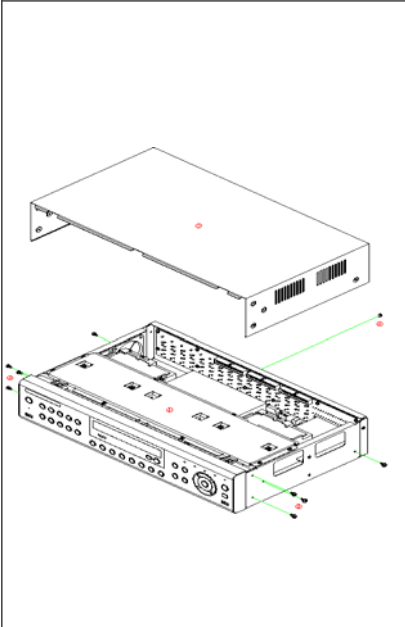

1) Using a screw driver, unscrew and take off the top case of the product.



- 1) Normal termination of the system and fully unplugged power code are required before conducting HDD installation.
- 2) Touch a grounded metal substance or ground yourself before installing HDD in order to reduce static electricity. Static electricity may cause a malfunction of the product.
- 3) After installing HDD, Do not connect to power supply with the top case opened. The top case must be covered before usage.

2) Unscrew and separate the HDD bay.
Align screw holes and screw and fix additional HDD onto HDD bay.

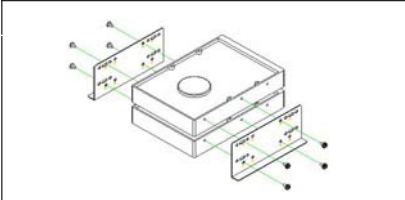

3) Screw the additional HDD bay to current HDD bay

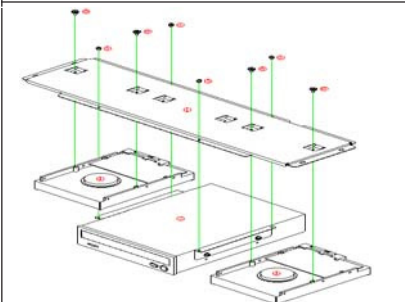

4) As per the photo, Screw the HDD bay and HDD and DVD

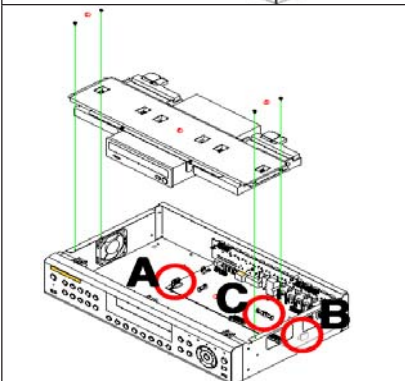

5) Connect the power cable and data cable to HDD.
Reassemble the top case by reversing 1) to finalizing HDD installation.

1-15 SVR series Storage Installation

※ Recommended HDD Specification



Type	Size	Capacity	Buffer	RPM
SATA I, II	3.5" 1, 2 Flat	Up to 2 TB	over 8MB	over 7200

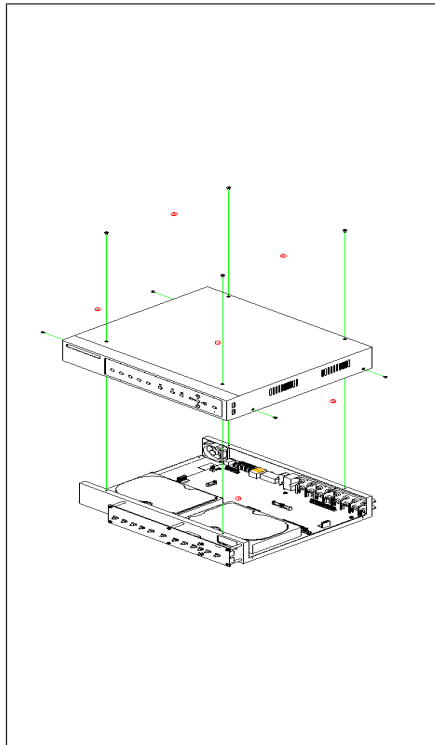

1) Using a screw driver, unscrew and take off the top case of the product



1) Normal termination of the system and fully unplugged power code are required before conducting HDD installation.
 2) Touch a grounded metal substance or ground yourself before installing HDD in order to reduce static electricity. Static electricity may cause a malfunction of the product.
 3) After installing HDD, Do not connect to power supply with the top case opened. The top case must be covered before usage.

2) Unscrew and separate the HDD bay.
 Align screw holes and screw and fix additional HDD onto HDD bay.

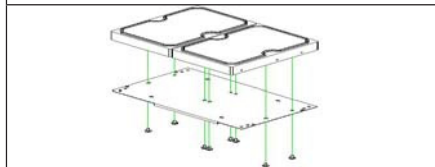

3) Screw the additional HDD bay to current HDD bay

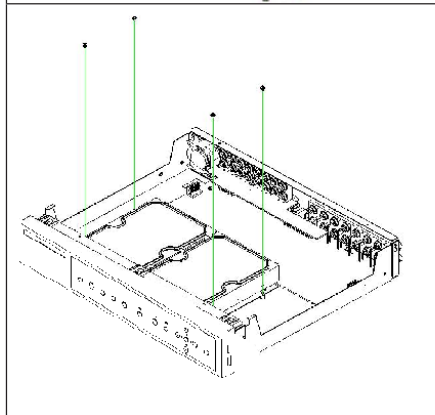

4) Connect the HDD to HDD connector on the main board directly without cable.
 Reassemble the top case by reversing 1) to finalizing HDD installation.

1-1 6 Power ON.

Check the adapter (12VDC/3.5A) and connect the power. Booting will be initiated by pressing the power button in the front panel. Booting is progressed step by step by VGA outputting or a color bar test screen for TV outputting, Live screen and a clock.

Menu widow pops up by clicking the right button of the mouse or pressing [MENU] button in the front panel as shown below.



[Figure 4-5. Menu Window]



ID and Password are required for a initial installation. Default ID and Password are shown below.

[Local Admin : 00000]

[User1 : 1111111] [User2 : 2222222] [User3 : 3333333] [User4 : 4444444]

1 - 1 7 Storage Setup

- ① Select {Menu} {Setup} {Storage Device}. As shown below, newly installed HDD is shown at {NEW} tab.



Indication of “{ }” refers to one provision of the menu. Indication of “ ” refers to a sub-provision. Example> {Menu} {Setup} : go to Setup that is a sub-provision of Menu.

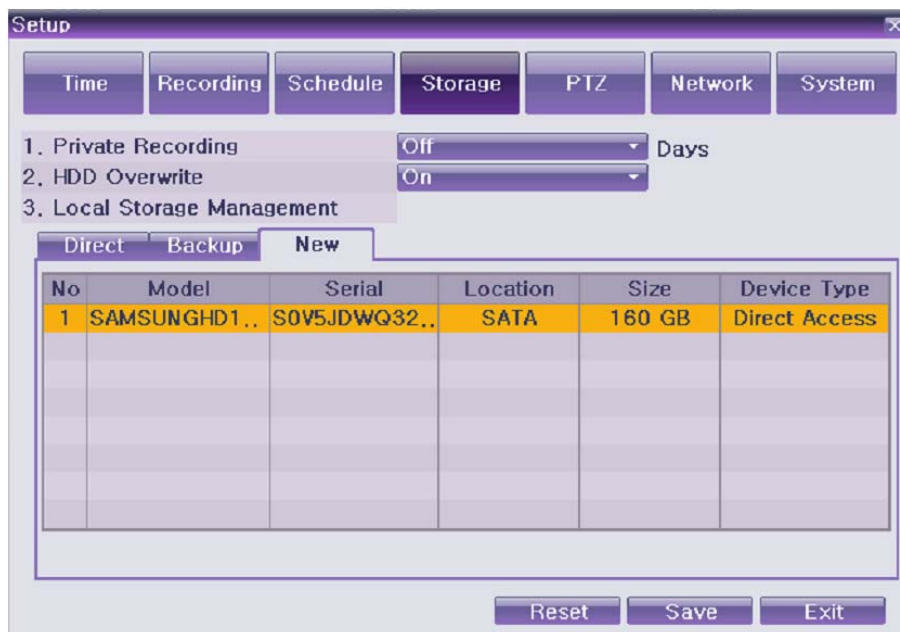

[Figure 4-6. Storage Device New Tab Window]



{New} tab is a manager that manages all newly introduced storage. All newly recognized devices are managed and allocated as a saving or backup storage in {New}.

- ② Move a focus onto {NEW} tab using the arrow keys and select.
- ③ Select Hard Disk.

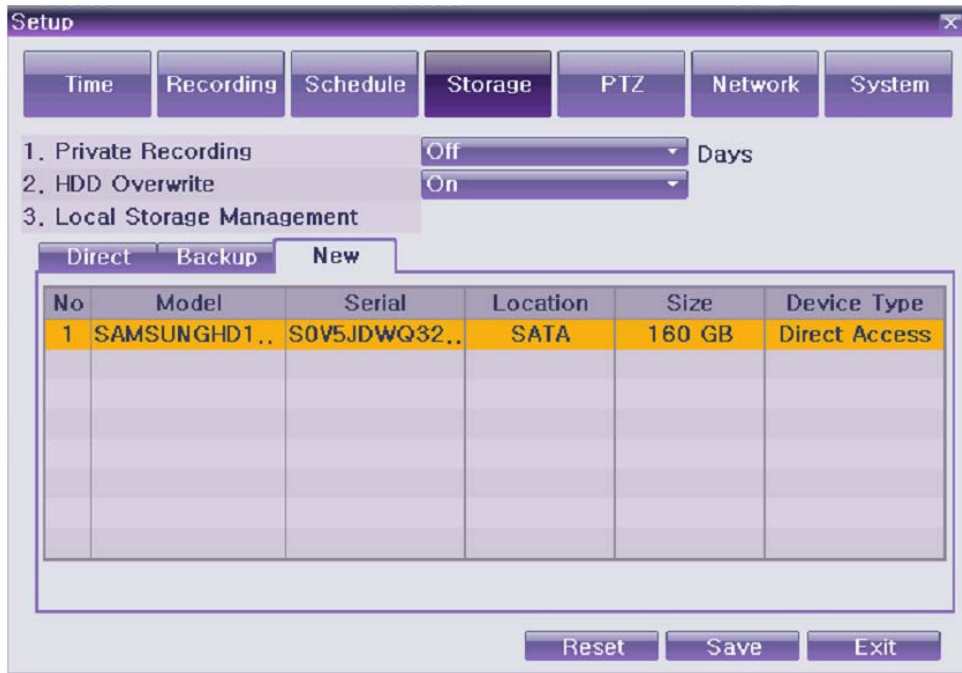

[Figure 4-7. Storage Device New Tab Menu Window]

Direct Initialize	Changes the selected storage into a dedicated direct storage.
Backup Initialize	Changes the selected storage into a backup storage.
	{New} At least, one storage shall be selected as a dedicated storage. Otherwise, the data cannot be stored in real time.

- ④ Select {Direct-Init} and follow {Direct-Init} procedure.



{Direct-Init} procedure may take time.

- ⑤ When it is completed, HDD is removed from **{New}** tab and shifted to **{Save}** tab.
 ⑥ Move to **{Save}** tab and select.
 ⑦ As shown below, it is indicated as **[ACTIVE/HEAL..]** in **{Status(SW/HW)}**, and HDD setup is completed.



[Figure 4-8. Storage Device Save Tab Window]



More detail description for HDD and Storage Device; check [6-4 Storage Device].

1 - 1 8 Recording Setup

- ① Select {Menu} {Setup} {Action}-> {Recording}.
- ② Setup for [Recording Resolution]/[Recording Quality]/[Mode]/[Recording Frame]/[Audio]/[Motion Detection]/[Sensor Detection]/[Event] and Alarm Output are available.



The initial recording setup is [Recording Resolution: CIF] [Recording Quality: High] [Mode: Auto]. An image of the connected cameras is recorded with above setting. For more detail, check [6-3 Action].

1 - 1 9 Date/Time Setup

- ① Select {Menu} {Set up} {Time}.
- ② Set up for [Time server]{Date and Time}{Standard Time Zone} are available.

1 - 2 0

Camera / TV Setup

- ① Select {Menu} {Set up}->{Definition}->{Camera}->{Adjust}
- ② Set up for [Brightness/Contrast/Color/Hue/Camera Adjustment/TV OUT Adjustment] are available.

1 - 2 1 External Device Setup

- ① Set up External Device. For more information, check [5-4 Audio Recording and Playback] [5-6 Spot Control] [5-7 Relay Out] [[6-5 PTZ] [6-6 Network] [6-2-5 Alarm Output] [6-7-10 Alarm] [6-7-11 Alarm Time Setup].

1 - 2 2 Recording View

- ① Select {Menu} {Search} {Calendar Search/Last Hour Playback/First Hour Playback/Move to Last Playback}.
- ② For more information, check '[5-8 Search] &[5-9 Calendar Search] &[5-10 Playback]'.

1 - 2 3 Backup

- ① Backup is available in Monitoring, Search, Log and Playback Mode.
- ② For more information, check '[5-13 Backup]'.
- ③ Log backup: You may save log list through USB memory stick.
- ④ Setup backup: You may save log list through USB memory stick.

1 - 2 4 DVR Information View

- ① Move to {Menu} {Miscellaneous} {DVR Info}.



Detail information for product functions are described below in this manual.

Chapter 5. System Operation

1 - 2 5

Starting and Exiting the System

1 - 2 5

- 1 Starting the System

- ① With the power connected, press the Power button.
- ① After the system is booted, images of all connected channels will be displayed.

1 - 2 5

- 2 Exiting the System



- ※ The default password for the local administrator is "00000."
- ※ To change the password, select {Main Setup} {System} {Local Administrator's Password}.

- ① Press the Power button on the remote controller.
- ② On the password input screen, enter a new password using the numeric buttons and the arrow keys.
- ③ After authentication is completed, the system will be terminated.



1 - 2 6 Monitoring

- **Various Screen Division and Auto Sequence.**
- **Channel Grouping.**
- **Spot**
- **Menu Controlling in Monitoring Mode**

After the system is booted, images will be displayed on a screen divided into [16/9/4] according to its setting. In case of 16 channels DVR, the screen can be divided into 1, 4, 9, and 16 sub-screens. Auto-sequencing from is available in each mode.

1 - 2 6

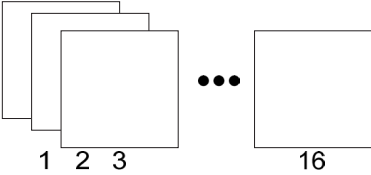
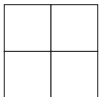
- 1 Screen Division and Auto Sequence

 Full Screen (16 groups)	 1 2 3 ... 16																		
Use the Full Screen mode. To view a certain channel, select the desired channel using the numeric buttons.																			
 4Sub-Screen (4 groups)	<table border="1" style="display: inline-table; margin-right: 10px;"> <tr><td>1</td><td>2</td></tr> <tr><td>3</td><td>4</td></tr> </table> <table border="1" style="display: inline-table; margin-right: 10px;"> <tr><td>5</td><td>6</td></tr> <tr><td>7</td><td>8</td></tr> </table> <table border="1" style="display: inline-table; margin-right: 10px;"> <tr><td>9</td><td>10</td></tr> <tr><td>11</td><td>12</td></tr> </table> <table border="1" style="display: inline-table;"> <tr><td>13</td><td>14</td></tr> <tr><td>15</td><td>16</td></tr> </table>	1	2	3	4	5	6	7	8	9	10	11	12	13	14	15	16		
1	2																		
3	4																		
5	6																		
7	8																		
9	10																		
11	12																		
13	14																		
15	16																		
Use the 4 Sub-Screen button.																			
 9Sub-Screen (2 groups)	<table border="1" style="display: inline-table; margin-right: 10px;"> <tr><td>1</td><td>2</td><td>3</td></tr> <tr><td>4</td><td>5</td><td>6</td></tr> <tr><td>7</td><td>8</td><td>9</td></tr> </table> <table border="1" style="display: inline-table;"> <tr><td>8</td><td>9</td><td>10</td></tr> <tr><td>11</td><td>12</td><td>13</td></tr> <tr><td>14</td><td>15</td><td>16</td></tr> </table>	1	2	3	4	5	6	7	8	9	8	9	10	11	12	13	14	15	16
1	2	3																	
4	5	6																	
7	8	9																	
8	9	10																	
11	12	13																	
14	15	16																	
Use the 9 Sub-Screen button.																			
 16Sub-Screen(1 group)	<table border="1" style="display: inline-table;"> <tr><td>1</td><td>2</td><td>3</td><td>4</td></tr> <tr><td>5</td><td>6</td><td>7</td><td>8</td></tr> <tr><td>9</td><td>10</td><td>11</td><td>12</td></tr> <tr><td>13</td><td>14</td><td>15</td><td>16</td></tr> </table>	1	2	3	4	5	6	7	8	9	10	11	12	13	14	15	16		
1	2	3	4																
5	6	7	8																
9	10	11	12																
13	14	15	16																
Use the 16 Sub-Screen button.																			
※ The user can view an image on full screen by double-clicking the 4/9/16 Sub-Screen mode. Double-click any part of the screen to return to the previous mode.																			
※ Auto Sequence Auto Sequence is to rotate images at an interval of the certain time in 1/4/9 Sub-Screen Mode. It changes to Auto Sequence Mode if you select {Menu} {Miscellaneous} {Display Mode} {Sequence} in 1/4/9 Sub-Screen Mode. Using the Up/Down button, the user can select the interval from 1 second to 10 seconds (to set the interval, however, multiple cameras should be connected).																			

1 - 2 6

- 2 Channel Grouping

Channel Grouping is to change the image location in the screen between channels.

- ① On the real-time monitoring screen, select **{Menu} {Miscellaneous} {Channel Grouping}**.
- ② On the monitoring screen, go to the channel selection window and select the channel to be changed in the group. Then the selection window pops up.
- ③ On the selection window, select a channel using the arrow keys and the Select button.
- ④ The Image location of the each channel is changed.

	<ul style="list-style-type: none"> ※ Group Setup is not supported for the 1-split mode. ※ The user can change the channel location in the group using the mouse. ※ Changing the screen division mode causes other division modes to be changed as well.
---	--

1 - 2 6

- 3 Spot

※ **Spot function is only available in SVR series.**

Spot is to output a channel that is set with a certain function. Spot has an independent monitor and output and only full screen mode is available.

① Event Spot

Event Spot is to show a channel quickly that is set with the Event function in case events (sensor and motion) occur. The event check interval is one second. If events are detected in many channels, it shows a channel with the last event. Move to **{Menu} {Setup} {Action} {Alarm Output} {Event Spot}**.

② Manual Spot

User can designate a spot channel manually. Move to **{Menu} {Control} {Spot}** and select a channel.

③ Sequence Spot

User can select more than one channel in Manual Spot and have a sequential image through Spot. Move to **{Menu} {Control} {Spot} {Sequence}**.

1 - 2 6

- 4 Menu in Monitoring Mode

User can control all functions available in Monitoring Mode in **{Menu}**.

- ① Press the Menu or right-click mouse button. The **{Menu}** will then appear.
- ② Select the desired item using the arrow keys or mouse.
- ③ Press the ESC button or right-click mouse button to hide the menu.

1 - 2 7 System Login

1 - 2 7

- 1 User Account and Authorization

System users are divided into local administrators and general users.

The local system administrator can use all functions.

Local Admin	The local administrator can use all functions: System Power On/Off, Setup, Monitoring, and Playback (remote access is not available, however).
User	Up to 15 users are allowed. Each user can access the functions depending on the given authorities. For Authorization Setup, Move to {Monitoring Menu} {Setup} {System} {4. User Registration} .

※ Functions available for Authorization Setup	
Network Live	Enable viewing real-time images upon network access.
Playback	Enable viewing the Recorded Screen.
Copy (Download)	Enable copying and downloading files from the network.
PTZ Control	PTZ camera control
Setup	Recording, Recording Schedule, System, Storage, Time, NTP, PTZ, Network Setup, Camera/TV Setup
Network Upgrade	Remote network upgrade
View Covert Channels	Enable viewing Covert channels.

1-2 7

- 2 Login

For security purpose, user must log in first to use {Monitoring Menu}.

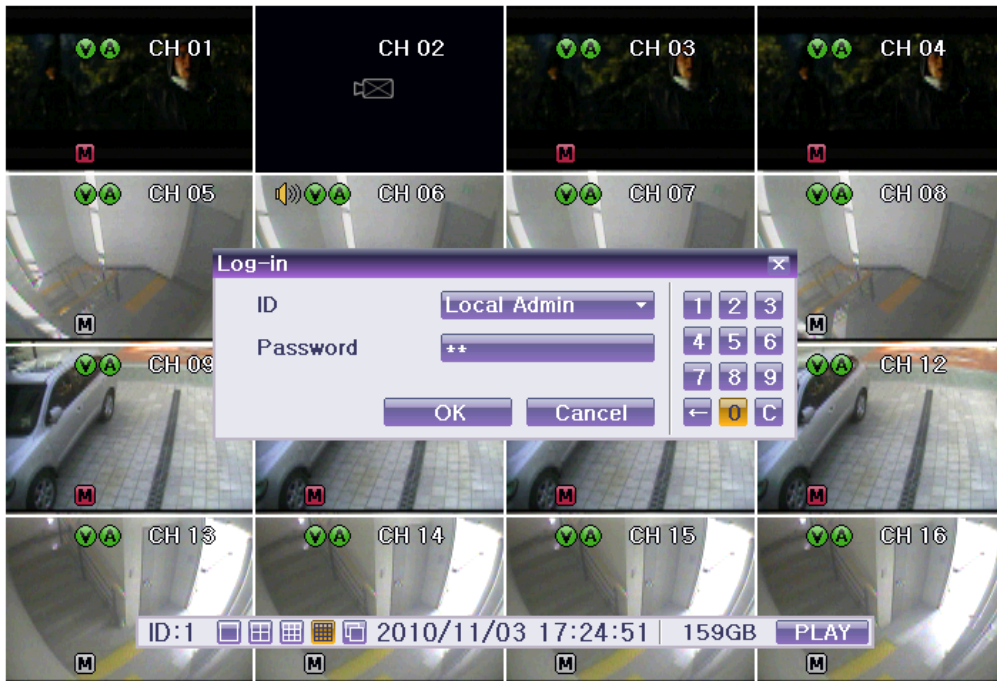

[Figure 5-9.

Login Window]

- ① On the real-time monitoring window, select {Menu} {Login}. The login window will then appear as shown in Figure 4-9.
- ② Enter the password or select the cancel.
- ③ You can select the space of password and enter alphabets for the password at the pop-up window.

1-2 7

- 3 Logout

After logging out, the user cannot use {Menu}.

- ① On the real-time monitoring screen, select {Menu} {Logout}.

1-2 8 Audio Recording and Playback



Each model; 16ch / 8ch supports 16/8 audio channels

16ch

Audio recording for video channel 1~16 is available.

8ch

Audio recording for video channel 1~8 is available.

1-2 8-1

Audio Recording Setup

- ① On the real-time monitoring screen, select {Menu} {Setup} {Action}.
- ② Select {Recording} {Audio} using the arrow keys and the Select button.
- ③ Set up the audio.

1-2 8-2 Audio Live

- ① On the real-time monitoring screen, select {Menu}-> ({Miscellaneous}-> ({Control}.
- ② Select the audio channel in {Audio} tab.

1-2 9

System Information View and Display Setup Change

Audio/Recording Status/Channel Title/Connection Indicator/Time/HDD status are displayed as shown below.



[Figure 5-10. Recording Status Window]

※ Recording Event / Recording mode display ※		
Recording Event		Motion recording
		Sensor recording
		Audio recording.
Recording Mode		Video recording.
		Audio recording

※ Live Display ※	
	Video is not connected or Video is covert
	Audio is set activated.
	Audio is set silent.
No Signal	Camera has been disconnected.

※ Control Bar ※	
①	DVR ID
②	1ch display mode
③	4ch display mode
④	8ch display mode
⑤	16ch display mode
⑤	Auto Sequence
⑦	Date / Time
⑧	HDD Status
⑨	Playback

1-2 9

- 2 System Information

- ① On the real-time monitoring screen, select {Menu} {Miscellaneous} {DVR Info.}.
- ② Product information mode will then be displayed as shown below.

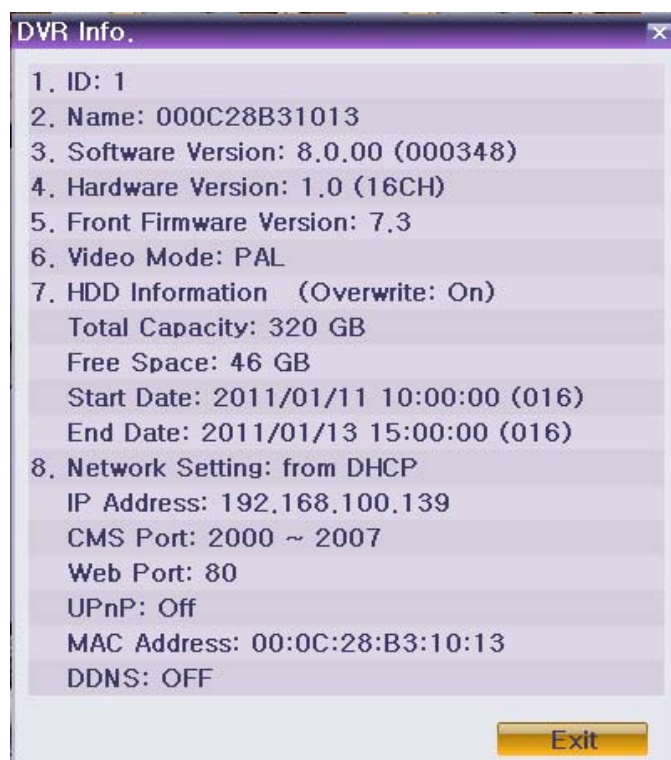

[Figure 5-11. Product Information Window]



ID is an identification(1~99, 255) of the product. The remote controller ID must match the identification to control DVR system.

1-2 9

-3 Camera Selection for Screen Setup

- ① On the real-time monitoring screen, select **{Menu} {Set Up} {Definition}**.
- ② Select a camera for Screen Setup. If you tick on All Channels, you can set up screen over all channels.



[Figure 5-12. Camera/TV Setup Window]

1-2 9

-4 Screen Brightness

- ① On the real-time monitoring screen, select **{Menu} {Miscellaneous} {Adjust} {Brightness}**.
- ② Select a channel to be adjusted.
- ③ Adjust the brightness of the selected channel using the arrow keys.
- ④ Adjust the other channels by repeating ② and ③.

1-2 9

-5 Contrast

- ① On the real-time monitoring screen, select **{Menu} {Miscellaneous} {Camera/TV Setup} {Contrast}**.
- ② Select a channel to be adjusted.
- ③ Adjust the contrast of the selected channel using the arrow keys.
- ④ Adjust the other channels by repeating ② and ③.

1-2 9

-6 Camera Adjustment

You can adjust a position of each camera by Up/Down/Left/Right.

- ① On the real-time monitoring screen, select **{Menu} {Miscellaneous} {Camera/TV Setup} {Camera Adjustment}**.
- ② Select a channel to be adjusted.
- ③ Adjust the contrast of the selected channel using the arrow keys.
- ④ Adjust the other channels by repeating ② and ③.



Moving the camera, down, right, or left excessively may cause black or gray areas to appear on the screen. The level at which such condition does not occur is the proper control range for the camera.

1-2 9

-7 Camera Title Shown/Hidden

- ① On the real-time monitoring screen, select {Menu} {Miscellaneous} {Display Setup} {Camera Title}.
- ② Select the On/Off status using the arrow keys and the Select button.

1-2 9

-8 Screen Border Adjustment

- ① On the real-time monitoring screen, select {Menu} {Miscellaneous} {Display Setup} {Border}.
- ② Select the desired item using the arrow keys and the Select button.
- ③ After assigning the setup value per field, press the [Exit] button to exit the Border Line setup mode.



[Figure 5-13. Display Setup Window]

Border setting fields		
Field	Setup Value	Description
Mode setup	On	Display the border for each channel screen in varying modes.
	Off	Hide the border for each channel screen in varying modes.
Type	Internal	Hide the external border line.
	All	Display all border lines.
Thickness	2, 4	Set the thickness of the border.
Color	Black, White, Red, Green, Blue	Set the color of the border.

1-2 9

-9 Screen saver

- ① Select {Screen saver}
- ② Select the desired item using the arrow keys and the Select button.
- ③ Set up the Duration, starting and waiting time.



[Figure 5-14. Screen Saver]

1-2 9

-1 0 Spot & Main display repeating ① Select {Spot or Main display repeat}

- ② Set up the repeating time(1-10) and sequence duration.



[Figure 5-15. Spot Sequence time]

1-2 9

-1 1 TV OUT Adjustment

TV OUT Adjustment is to move the TV OUT screen Up/Down/Left/Right.

- ① On the real-time monitoring screen, select {Menu} {Miscellaneous} {Camera/TV Setup} {TV OUT Adjustment}.
- ② Adjust the CCTV monitor screen up/down or Right/Left using the arrow keys.



Moving the monitor up, down, right, or left excessively may cause black or gray areas to appear on the screen. The level at which such condition does not occur is the proper control range for the monitor.

1 - 3 0 Spot Control

※ Spot function is only supported in SVR series



[Figure 5-14. Spot Control Window]

- ① On the real-time monitoring screen, select {Menu} {Miscellaneous} {Control} {Spot}.
- ② Select a channel or Sequence, and then the selected channel screen will be displayed.

1 - 3 1 Relay Out

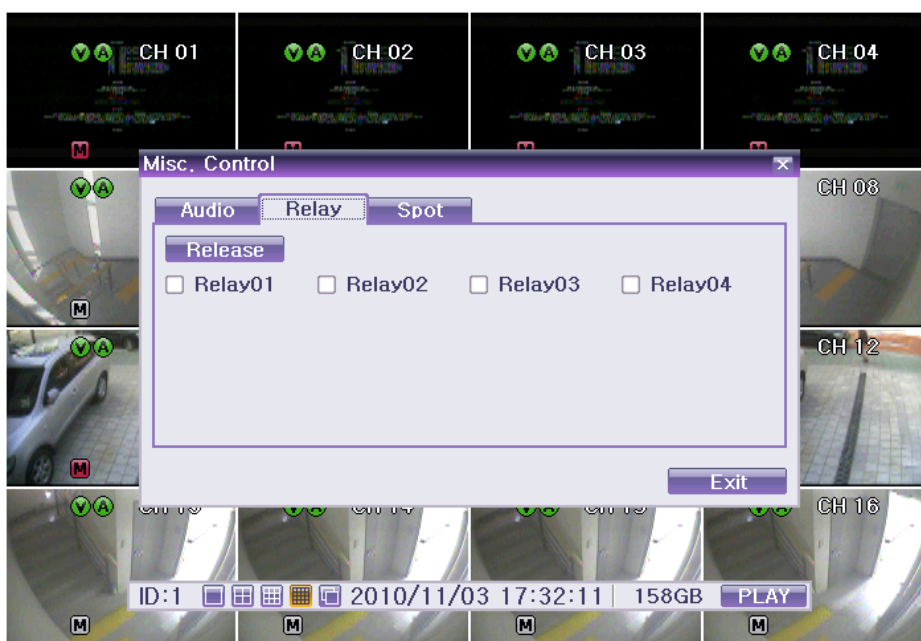

[Figure 5-15. Relay Control Window]

[Figure 5-15. Relay

- ① On the real-time monitoring screen, select {Menu} {Miscellaneous} {Control} {Relay}.
- ② Selecting a relay channel enables outputting and canceling the relay.

1-3-2 Search

1-3-2-1 Search Mode

- 1 Search Mode

For Search mode, select {Menu} {Search} in real-time monitoring mode.

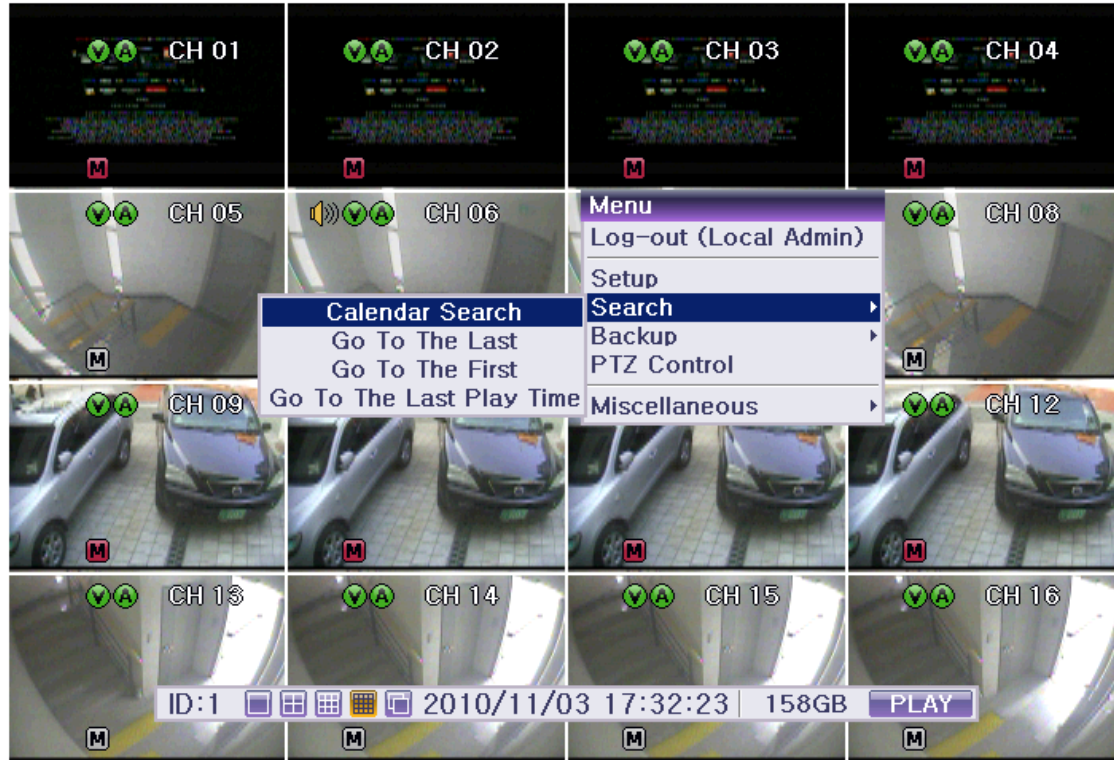

[Figure

5-16. Playback Menu Window]

1-3-2-2 Playback Menu

- 2 Playback Menu

Four Playback are available.

(1) Calendar Search

Calendar Search allows the user search and play back by [Year/Month/Day/Hour/Minute],[Multi-Channel/Multi-Time/Multi-Day]and [Motion/Sensor/Audio].

Selecting Calendar Search moves to the search window.

(2) Go To The Last

The user can search and play back the last recorded data by Multi-Channel Mode. Selecting Go To The Last shifts to the playback screen.

(3) Go To The First

The user can search and play back the first recorded data by Multi-Channel Mode. Selecting Go To The First shifts to the playback screen.

(4) Go to The Last Played Time

The user can play back from the last played time by Multi-Channel Mode.



※ Go To The First and Go To The Last are only available in {Multi-Channel}.

1-3-3 Calendar Search

1-3-3

-1 Search Mode

On the real-time monitoring screen, select {Menu} {Search} {Calendar Search} and then a searching window pops up as shown below.

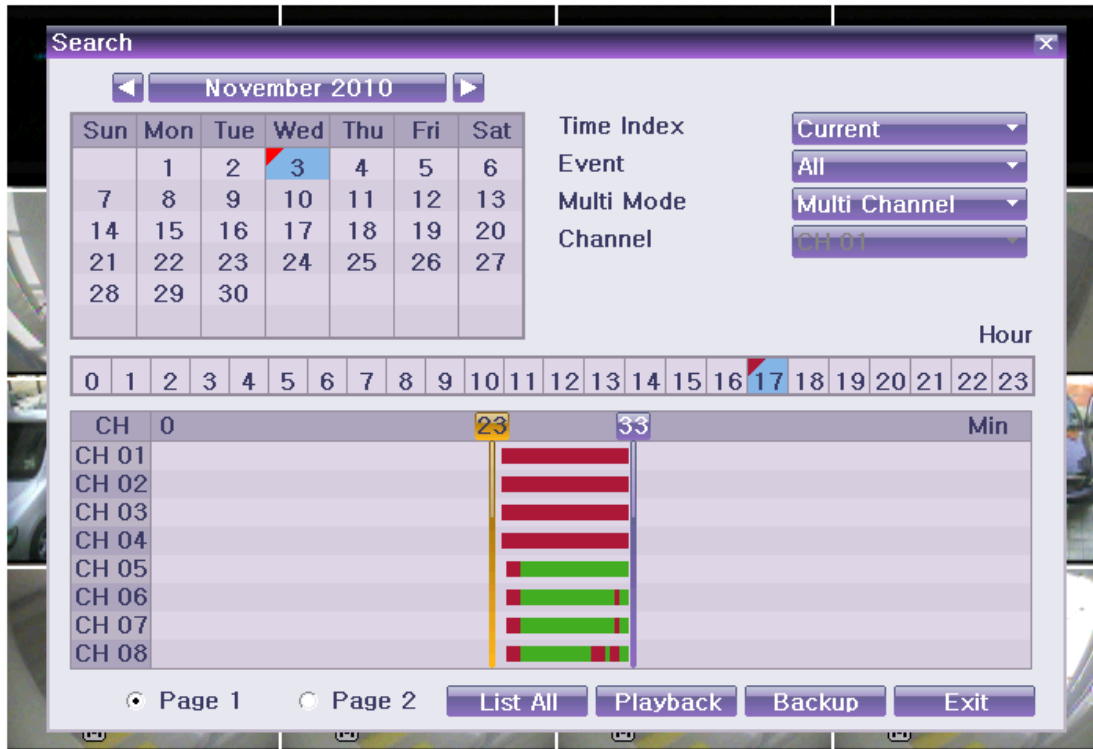

[Figure

5-17. Search Window]

1-3-3

-2 Year/Month/Day Selection

Select the desired [Year/Month/Day]. The color of the icon at the top-left day square in the calendar indicates the recording status.

1-3-3

-3 Directory Count

- ① Every time when the user changes the time at {Menu} {Setup} {Time} {Date and Time} tab, a new folder(Directory) is created and files saved in the folder before the time change is indicated sky-blue in the file list.
- ② Selecting a file in blue-sky leads to a selection window popup and the user can select a file in different folder (before time change).

	※ Searching by the file list is only available in Multi-Channel Search.
Current	Recorded image files with the current set time.
Old_Number	Recorded image files before the time change.

1-3-3

-4 Event





Event is to search the data by the events. Select [All/Motion/Sensor/Audio].

1-3-3

-5 Multi-Channel Search

Multi-Channel Search is to play the recorded image of the different channel over a certain designated time.

- ① Using the arrow keys and the Select button, select the desired Year/Month/Day in the activated calendar window.
- ② On the calendar window, select the desired search date. The recorded one-hour video of each channel is then displayed in a bar graph.

	Green	Continuous recording is in progress.
	Red	Motion recording is in progress.
	Blue	Sensor recording is in progress.
	Yellow	Audio recording is in progress.

- ③ Move the time line to a specific time point using the arrow keys or the numeric buttons and press the Search button.
- ④ Selecting the time causes the recorded video for each channel to be displayed as a bar graph in minute units.
- ⑤ Move the time line to a certain time point using the arrow keys and the numeric buttons and press the Select button. Playback will then start from the specified time point.

1 - 3 3

- 6 Multi-Time Search

The user can play back the video contents of a certain channel recorded in different time zones.

Multi-time data can be searched in Multi-time Search mode.

- ① The user can search data by date as in the Multi-Channel Search mode.
- ② Time zones and channels may be viewed by selecting the desired date.
- ③ Select the start time and the channel using the arrow keys.
- ④ The hourly recorded video of the selected channel will then be displayed as a bar graph in minute units.
- ⑤ Move the time line using the arrow keys and the numeric buttons and specify the time. Afterward, press the Start button and play back the contents.



※ A different time zone means continuous 16 hours.

1 - 3 3

- 7 Multi-Day Search

The user can play back the video contents of a certain channel recorded in different days.

Multi-time data can be searched in Multi-Day Search mode.

- ① The user can search data by date as in the Multi-Channel Search mode.
- ② The date list and the recording status from the date the user selects, are viewed by selecting the desired date.
- ③ Select the start time and the channel using the arrow keys.
- ④ The recorded video of the selected channel will then be displayed as a bar graph in minute units.
- ⑤ Move the time line using the arrow keys and the numeric buttons and specify the time. Afterward, press the Start button and play back the contents.



※ A different time zone means continuous 16 hours.

1 - 3 4 Playback

There are five routes to play the recorded image.

Playback in Calendar Search

Select **{Playback}** in **{Menu}** **{Search}** **{Calendar Search}** **{Search}**.

Playback in Go To The Last

Select **{Menu}** **{Search}** **{Go to The Last}**.

Playback in Go To The First

Select **{Menu}** **{Search}** **{Go To The First}**.

Playback in The Last Played Time

Select **{Menu}** **{Search}** **{The Last Played Time}**.

Playback in Log View

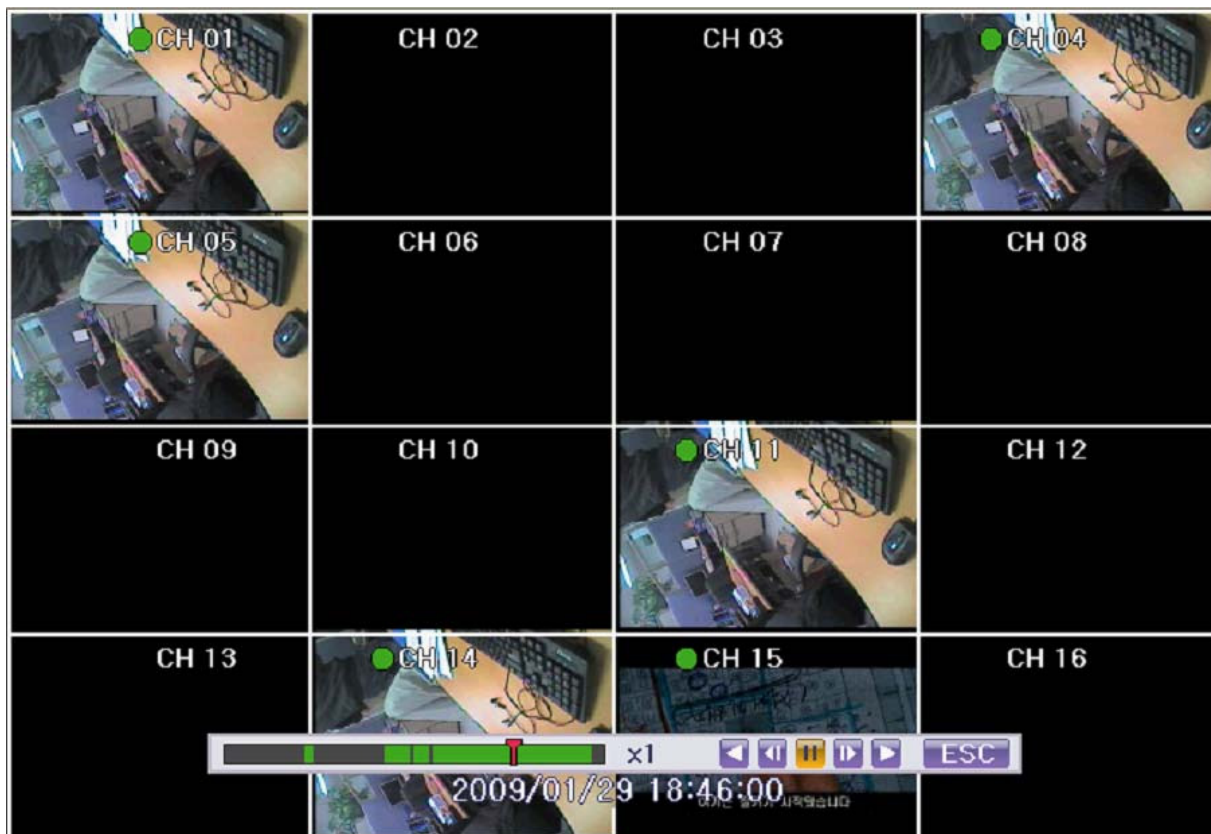

After selecting **{Menu}** **{Miscellaneous}** **{Log Viewer}**, select or double-click the time line listed to

play.







[Figure 5-18. Playback Screen]

1-3 4-1 Playback and Playback Speed Control

- ① In Playback mode, the user can play back video contents using the button functions below.
- ② After the data is played to the end, the data of the next time zone will be automatically searched and played (this function is possible only in Multi-channel Playback mode; both backward playback and forward playback are possible).
- ③ Pressing   buttons, the user can adjust the playback speed by (x 1) / (x 2) / (x 4) / (x 30).



[Figure 5-19. Playback Status and Control Window]

Description of the Search Buttons		
Button	Name	Features
	Forward Play / Fast Forward	Press one time - Playback forward (x 1) Press two times - Fast forward (x 2) Press three times - Fast forward (x 4) Press four times - Fast forward (x 30) Pressing one more time in x30 leads to x1 back.
	Forward Frame by Frame	Playback frame-by-frame Pause
	Pause	Pause
	Reverse Frame by Frame	Reverse playback frame by frame Pause
	Reverse Play / Fast Reverse	Press one time - Playback reverse (x 1) Press two times - Fast reverse (x 2) Press three times - Fast reverse (x 4) Press four times - Fast reverse (x 30)

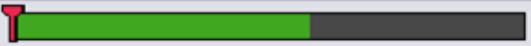
		Pressing one more time in x30 leads to x1 back.
	ESC	Exit to Playback Mode.
		Status bar indicating information of the hourly recorded image data

Selecting the right-mouse button or menu button in Playback Mode pops up the {Playback Menu}.



[Figure 5-20. Playback Menu]

Items in {Playback Menu} are shown below.

1-3 4-2 Smart Search

This function is used to search an image with the object movement at a specific zone fast. Searching by each channel is available.

- ① Move to Smart Search and select the desired channel.
- ② Then, it shifts to 1 channel mode and the searching starts with a window shown below.

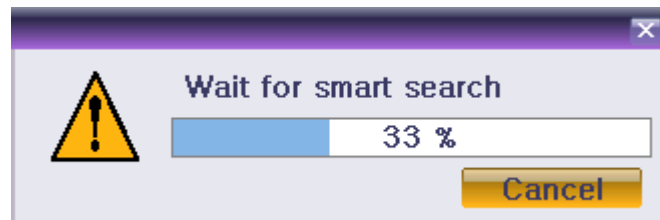

[Figure 5-21. Smart Search Motion Detection Window]

- ③ It may take time during the searching.
- ④ Start the playback after the searching.

1-3 4-3 Calendar Search

Move to Calendar Search in {Menu} {Search} {Calendar Search}.

1-3 4-4 MULTI TIME

Multi-Time is to play the recorded image of the different time over a certain designated channel. The lineup of the recorded image of the different time is the most recent-bottom.

1-3 4-5 MULTI DAY

Multi-Day is to play the recorded image of the different day over a certain designated channel. The lineup of the recorded image of the different time is the most recent-bottom.

1-3 4-6 MULTI CHANNEL

Multi-Channel is to play the recorded image of the different channel over a certain designated time.

1-3 4-7 Event

Event is to play the recorded image with [All/Motion/Sensor/Audio].

1-3 4-8 Audio

Select the desired audio channel to play.

1-3 4-9 Backup

Save the backup image and captured image into [CD/External Storage].

Backup	Save the backup image data into [CD/External Storage].
Snapshot	Capture and save an image of screen being monitored.

1-3 4-1 0 De-Interlace

De-Interlace function could be selected (On/ Off) for the playback of 4CIF recorded images.

1-3 4-1 1 Display Mode

The user can divide the screen in Playback Mode as same as in Monitoring Mode.

- ① Select Screen Mode and Screen Mode window as shown below pops up.

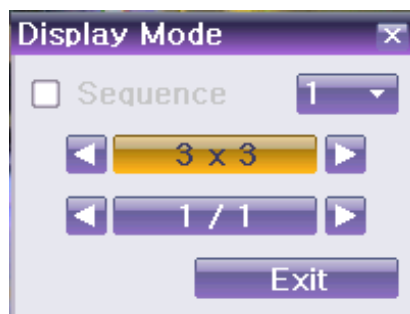

[Figure 5-22. Display Mode]

- ② Select [1/4/9/16 Mode].

1-3 4-1 2 Status Bar

Select Activation or Deactivation below Playback Mode [Figure 5-23. Playback Status and Control Window].

1-3 5 Log Viewer

DVR records all Log information over the system operation including Power on/off, System Setup and Network Access. Move to {Menu} {Miscellaneous} {Log Viewer} to see the logs.

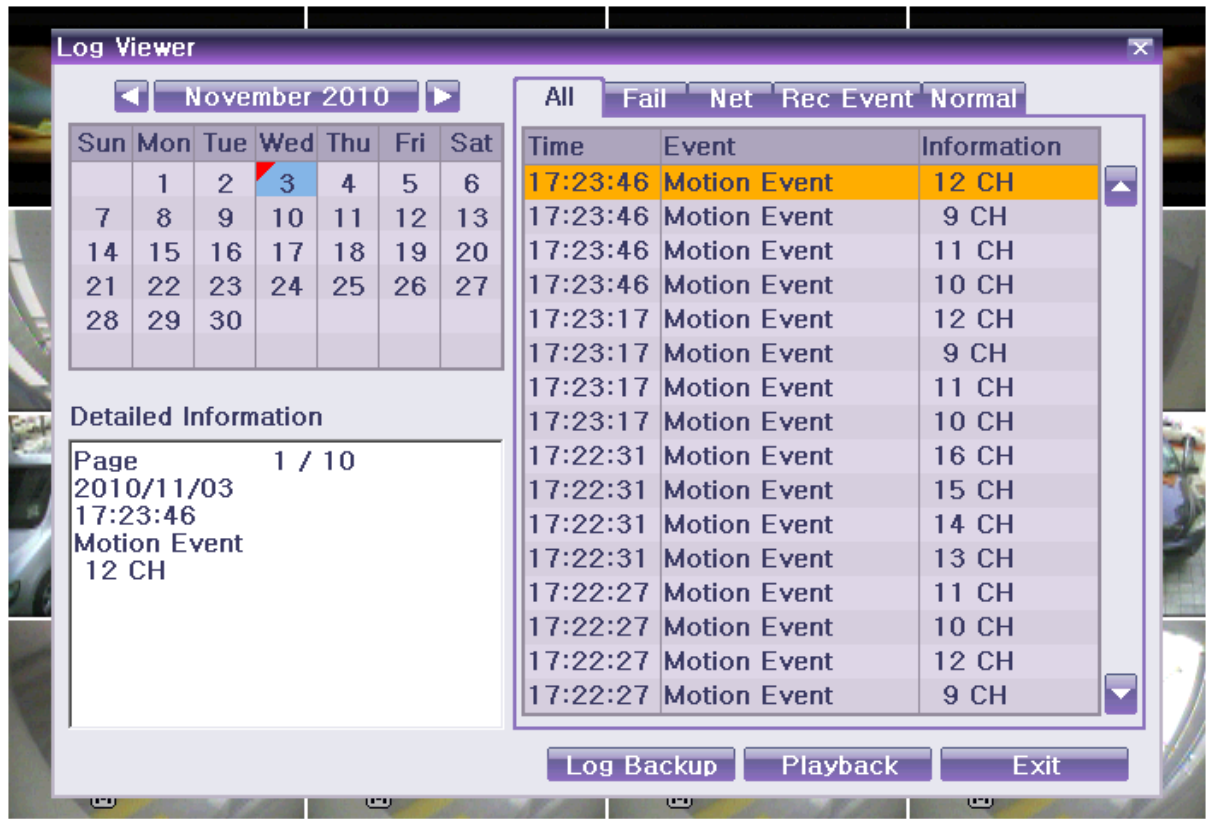

[Figure 5-23. Log Viewer]

1-3 5-1 Log Type

General	Logs related to power ON/OFF, file copy/backup failure, setup start/end, playback, and other basic system operations
Recording Event	Logs related to recording, e.g., motion detection and sensor detection, Audio detection
Network	Logs related to network operations e.g., network login, network logout, and network live
Fail	Logs related to system operation failures, e.g., signal loss and network connection failure
All	Logs related to all system operations

1-3 5-2 System Log Viewer

- ① In real-time monitoring mode, **{Menu}** **{Miscellaneous}** **{Log Viewer}**, then, Log List Window pops up.
- ② On the activated calendar window, Select the desired date (year/month/date) using the arrow keys and the Select button.
- ③ The user can check the time and the log type using the arrow keys in the log list.
- ④ Use the menu button to check the logs by time and type on each page.
- ⑤ The user can shift the focus to a certain time zone for playing the certain time (playback will start from the time point when logs are saved).
- ⑥ Click the right-mouse button or select **{Menu}** button in the front panel and select **{Hour}** to move the desired log time zone.

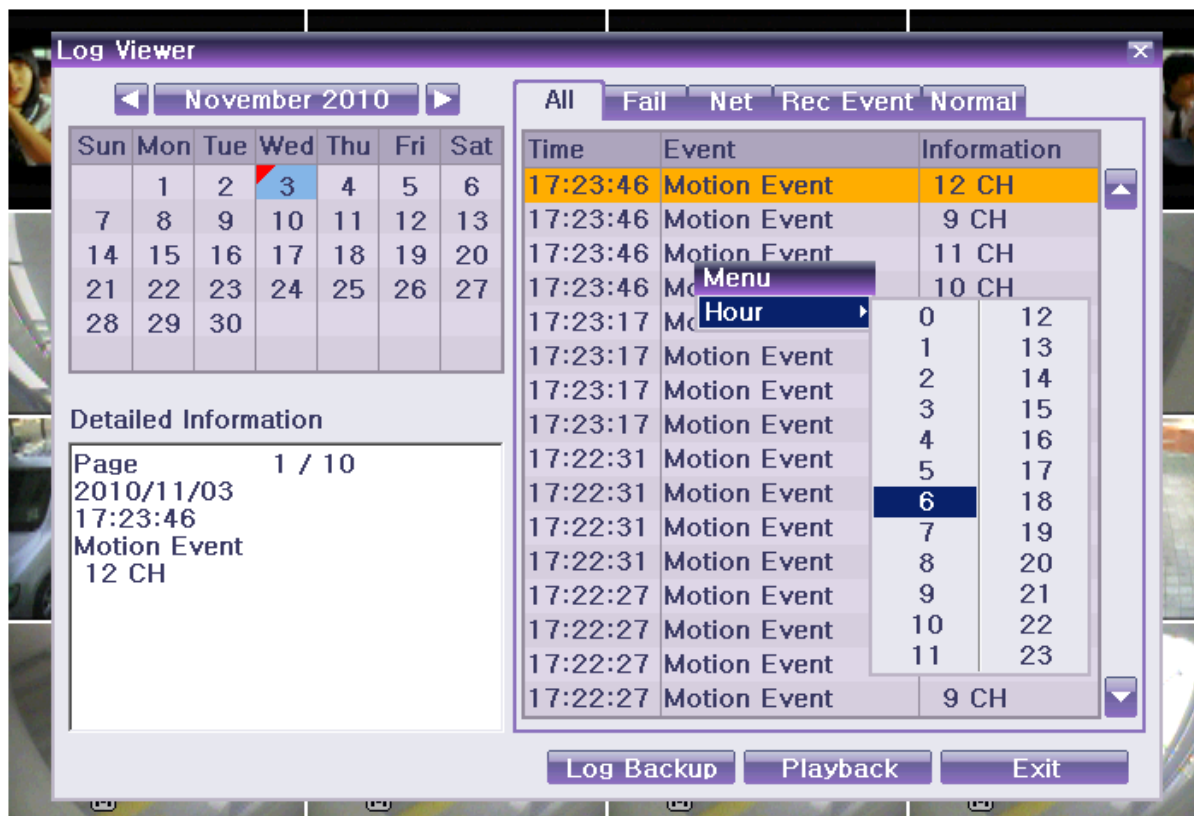

[Figure 5-24. Move to the log list of the certain time zone]

	<p>Time Changed Log Data View</p> <p>The stored data folder is updated each time the user changes the time. A blue triangular icon is displayed on the date each time a change is made in the date on the calendar window. Otherwise, a red triangular icon is displayed on the unchanged date. To view the log details, select the desired date with a red icon. Selecting a date with a blue icon causes the changed date list to appear.</p>
---	--

1-3 6 Recording

1-3 6

-1 Recording Types

It supports various recording types as shown below.

Recording Type	Description
Automatic	<p>Set the event recording frame and general recording frame separately. Depending on the set value, select the recording type automatically and proceed with the recording.</p> <p>When motion, sensor and audio are detected, the event recording frame will be selected. Otherwise, the general recording frame will be selected.</p>

Continuous	Continuous recording will be initiated based on the general frame value.
Motion	When motion is detected, recording will be initiated based on the event frame value.
Sensor	When input signal from an external sensor is generated, recording will be initiated based on the event frame value.
Audio	When audio is detected, recording will be initiated based on the event frame value.

1 - 3 6





- 2 Recording Setup

Go to **{Menu} {Setup} {Recording}** for Recording Setup. For more information, move to **{Menu} {Setup} {Recording} {Recording}**.

1 - 3 6

- 3 Recording Status View (1)

Recording Status by Color

	Green	Continuous recording is in progress.
	Red	Motion recording is in progress.
	Blue	Sensor recording is in progress.
	Yellow	Audio recording is in progress.

(2) Starting and Stopping Record All

In real-time monitoring mode, the user can start or stop the recording of all channels by selecting **{Menu} {Miscellaneous} {Record On/Off}**.

(3) Stopping Record All

- ① In real-time monitoring mode, select **{Menu} {Miscellaneous} {Record On/Off}**.
- ② Enter the password of the local system administrator.
- ③ On the recording stop confirmation window, select the(Yes) button.
- ④ Any channel recording in progress will then stop, and the corresponding status will be displayed on the recording status window.

(4) Starting Record All

- ① In real-time monitoring mode, select **{Menu} {Miscellaneous} {Record On/Off}**.
- ② On the login window, enter the password of the local system administrator.
- ③ The recording of all channels will then start based on the previous setting, and the recording status will be displayed.

1 - 3 7 Backup

To back up data, the PC shall be equipped with CD and DVD or connected with a storage device such as HDD, CD and DVD via the USB 2.0 port. The user can back up data in real-time monitoring, search, log, or playback mode.

1 - 3 7

- 1 Backup in Real-time Monitoring Mode

- ① In real-time monitoring mode, select **{Menu} {Backup} {Backup}**. The backup menu will then appear.
- ② The automatic backup time is set to 5 minutes before the Copy (Backup) button is pressed, and the end time, to the time the Copy (Backup) button is pressed.
- ③ All channels containing data at the time of backup are backed up automatically. Depending on the divided screen mode, however, only those channels that can be viewed may be selected.
- ④ For the remaining backup procedures, see **{5-13-5 Common Backup Procedure}**.

1-3 7

-2 Backup in Search Mode

- ① Select {Menu} {Search} {Calendar Search}.
- ② Click the right-mouse button or select {MENU} button in the front panel.
- ③ The automatic backup start time is set to the year/month/date/hour/minute set in search mode, and the end time, to the last minute/second of the data existing at the selected time.
- ④ All channels with existing data at the time of backup are backed up automatically.
- ⑤ For the remaining backup procedures, see {5-13-5 Common Backup Procedure}.

1-3 7

-3 Backup in Log Mode

- ① Select a date in {Menu} {Miscellaneous} {Log Viewer} and select a log related to the data to be backed up.
- ② Click the right-mouse button or select {MENU} button in the front panel.
- ③ The automatic backup time is set to 5 minutes before the selected log is generated, and the end time, to the time the selected log is generated.
- ④ All channels with existing data at the time of backup are backed up automatically. If a log has been generated for a specific channel, however, then only that channel is selected.
- ⑤ For the remaining backup procedures, see {5-13-5 Common Backup Procedure}.

1-3 7

-4 Backup in Playback Mode

- ① In Playback mode, select {Menu} {Backup}. Any playback in progress at this time will stop.
- ② The automatic backup time is set to 5 minutes before the Copy (Backup) button is pressed, and the end time, to the time the Copy (Backup) button is pressed.
- ③ All channels containing data at the time of backup are backed up automatically. Depending on the divided screen mode, however, only those channels that can be viewed may be selected.
- ④ For the remaining backup procedures, see {5-13-5 Common Backup Procedure}.

1-3 7

-5 Common Backup Procedure

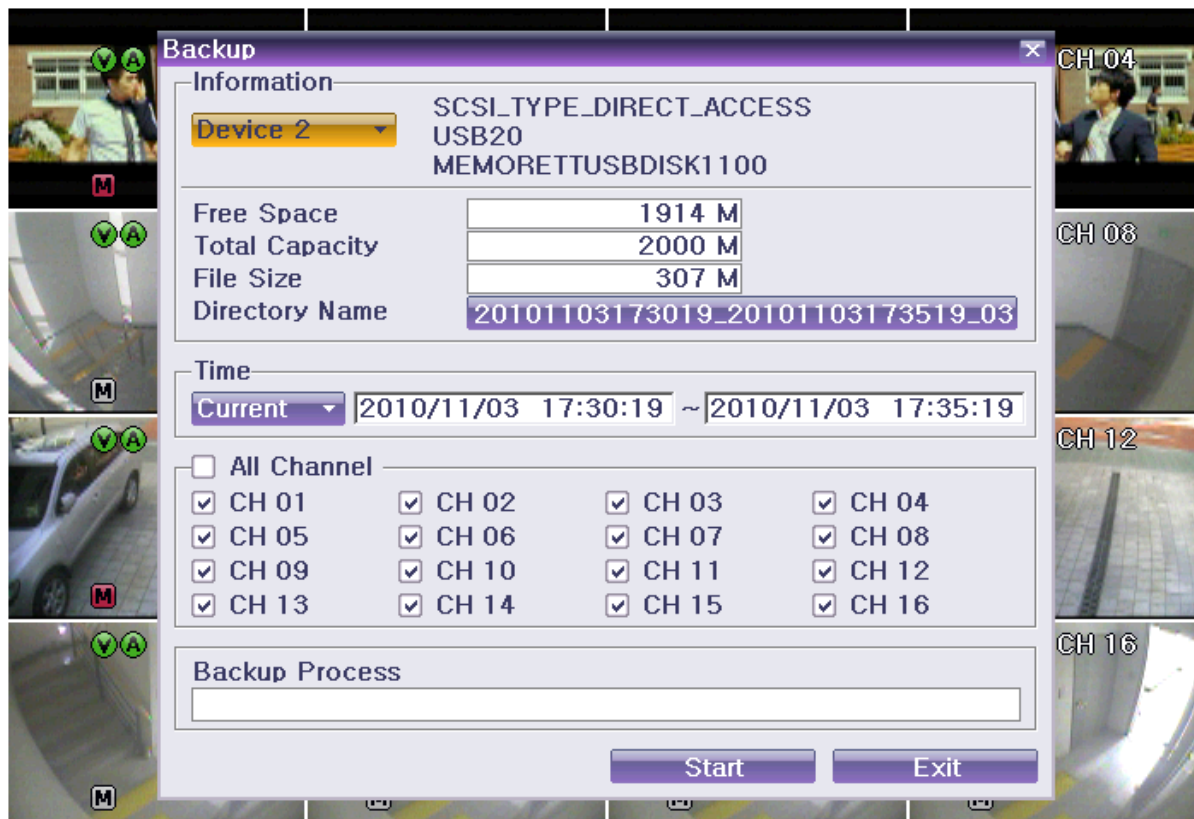

[Figure 5-25. Backup Window]

- ① [Figure 5-29] shows the initial backup window menus.
- ② A list of devices that can be selected as well as simple information on the currently selected devices are outputted.
- ③ Selecting a device by pressing the Select button causes the free space and total capacity for the selected device to be displayed.
- ④ Selecting a device causes the directory name based on the initial values for the time and channel to be displayed and the size of the file to be backed up to be calculated.
- ⑤ The directory name is set up using the backup time. The first 12 digits are determined by the year/month/date/hour/minute/second for From, and the 12 digits in the middle, by the year/month/date/hour/minute/second for To. The last 2 digits are determined by the number of folders in the selected device.
- ⑥ Selecting a device enables selecting the backup time as well. As a rule, the From time cannot be later than the To time, and the To time cannot be earlier than the From time.
- ⑦ To change the start and end time, press the Select button after choosing the start and end time. Change year/month/date/hour/minute/second by using arrow keys and press ESC button.
- ⑧ Changing the backup time causes the name of the directory to be backed up to be changed as well.
- ⑨ If the file to be backed up exceeds the free space, its size is displayed in a yellow box in case the selected device is capable of rerecording and in a red box if not.

	<p>If the backup storage device is not formatted, in case the box displaying the size of the file to be backed up is displayed in yellow, and if backup is executed by pressing the Copy (Backup) button, a prompt asking whether to erase the device will appear as shown below. Selecting [YES] causes the storage medium for the selected device to be erased.</p>
---	---

- ⑩ Press the Copy (Backup) button. A prompt asking whether to proceed with the backup or not will then be displayed.



※ Select [Yes] to back up the data or [No] to stop the backup. Otherwise, press the [Cancel] button to return to device selection mode on the backup window.

- ⑪ Select {Yes} to continue the backup.

1 - 3 8 Log Backup

All of recorded log data such as Normal/ Recording Event/ Network/ Failure could be backed up.

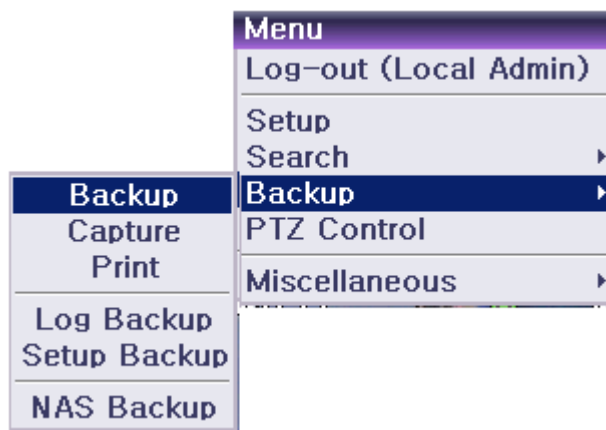

[Figure 5-26. Backup and Sub-menu log backup window]

- ① You can start after the setup at {Menu} {Backup} {Log Backup}.

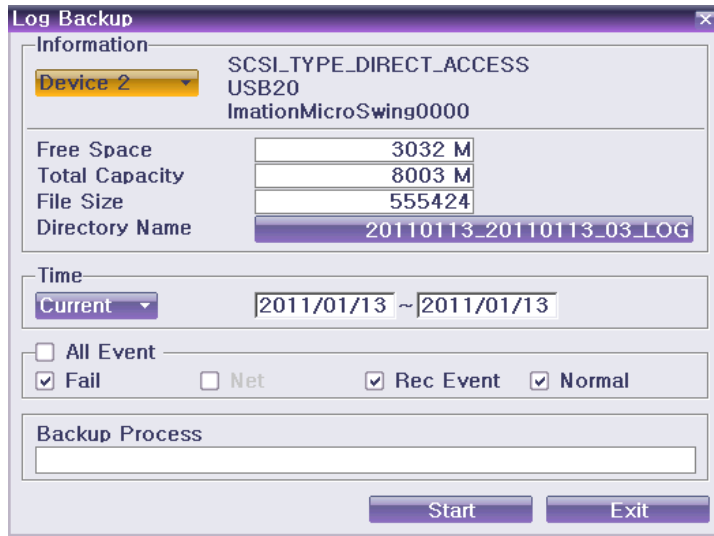

[Figure 5-27. Log backup window]

Log file will be made in the folder below.



20100303_20100303_02_LOG

565645348945_20100303.log

(Log file is text format so the file could be open easily)

1 - 3 9 Setup Backup

By this function, Setup data could be backed up. The setup data backed up could be applied to other DVR.

- ① The devices for the backup should be connected.
- ② At {Menu} {Backup} {Setup Backup}, the message below will be displayed and setup data will be backed up with the file name following the form below.

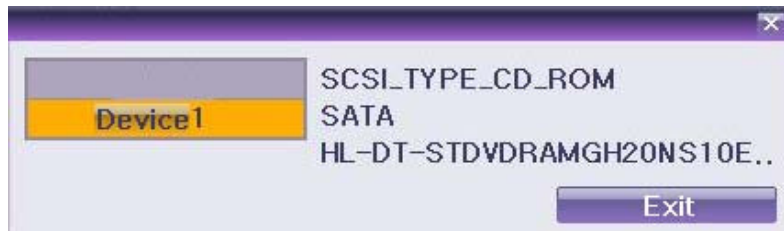

[Figure 5-28. Seup Upgrade window]

Setup data will be backed up by the file format below.



HM1648_000C28B323D1_80_314_20100806_135657.bin

① Model name ② DVR name ③ ver. ④ Date ⑤ Time

- ③ After the backup device(ex:USB) connection to other DVR, the upgrade should be done at {M} {Setup} {System} {6. Upgrade}->{Setup}.
- ④ New DVR will be upgraded with the setup data.

1-4 0 NAS Backup



[Figure 5-26. NAS Backup Window]

- ① Select **{Menu} {Backup} {NAS Back}** in real-time monitoring mode, NAS backup window pops up.
- ② NAS Use : NAS Backup On/Off.
- ③ NAS Server IP : Enter NAS device IP.
- ④ Mount Point : Upper directory for backup data is made (ex : /raid0/data/b3)
- ⑤ Directory(DVR name) : Designate a directory where the backup data is saved.
- ⑥ Overwriting : Overwriting On/Off.

1-4 1 Snapshot

The Snapshot function lets the user create a JPG file in real-time monitoring, playback, search, or log mode and back up the image data.

- ① To back up the currently displayed image, select **{Menu} {Backup} {Snapshot}** in real-time monitoring mode, or **{Menu} {Backup} {Snapshot}** in Playback mode.
- ② When only one USB2.0 backup device (excluding ODD devices) is searched, the JPG file is stored in the same device.
- ③ If there are no or more than two USB2.0 storage devices (excluding ODD devices), a window for selecting the device will be displayed.
- ④ If the selected device is an ODD device, a prompt asking whether to back up the ODD device will be displayed.

1-4 2 PTZ Camera Control

1-4 2-1 Conditions for Using the PTZ

- ① The PTZ camera must be connected to the system. For external connection, refer to **{2-4-2 Connection of Other Devices} {4} PTZ Camera/Keyboard Controller**.
- ② Select **{Menu} {Setup} {PTZ}** and check whether the PTZ camera setting is appropriate.



※ For more information on the PTZ camera setting, select **{Menu} {Setup} {PTZ}**.

1-4 2-2 PTZ Mode

- ① In real-time monitoring mode, select **{Menu} {PTZ Control}**.
- ② PTZ Control Window shows up. PTZ Control Window can be toggled as **{Max.}** or **{Min.}** as shown below.

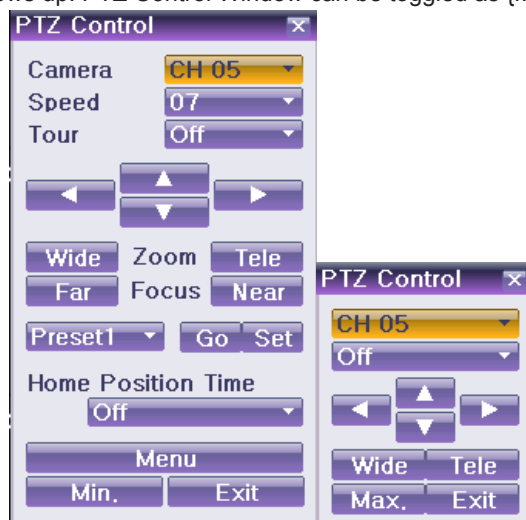

[Figure 5-27. PTZ Control Window (Max. Mode (Left) / Min. Mode (Right))]

- ③ A channel with PTZ set camera is activated in the yellow frame.

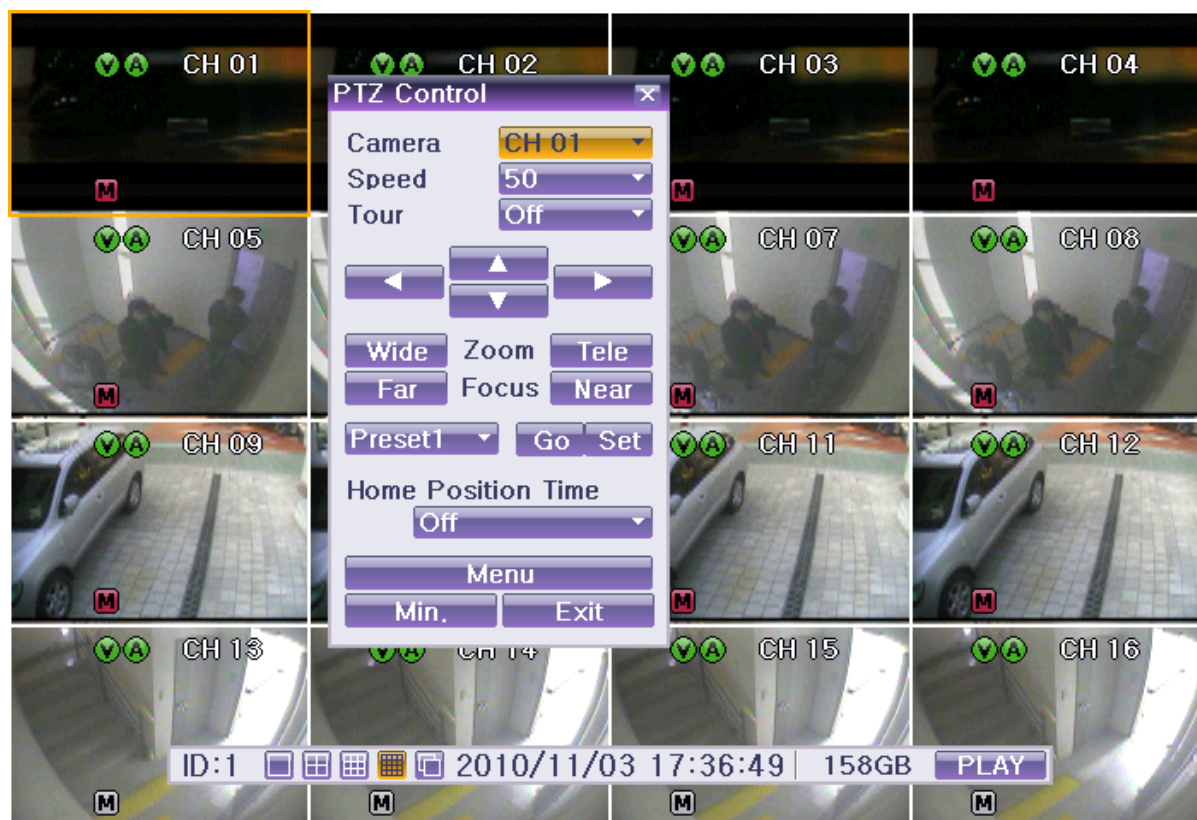



[Figure 5-28. PTZ Mode Initial Screen]

	Activation mode	The channel is selected, and the channel screen border is highlighted in orange.
--	------------------------	--

1-4 2-3 PTZ Control

(1) Camera

- ① Select the camera button. Only a channel with PTZ set camera can be activated.
- ② Select PTZ to be controlled.

(2) Speed

- ① PTZ camera speed is adjustable.

(3) Tour feature



※ For more information on setting the Tour feature, select {Menu} {Setup} {PTZ} {Tour}

- ① In Tour, you can select [Disable] / [Able]. If you choose [Able], [Tour 1] and [Tour 2] are available.
- ② 8 spots of PTZ preset are available for each [Tour1] and [Tour2].
- ③ In Tour {Menu} ({PTZ Control}, you can set up Tour1/Tour2 and [Disable].

(4) Horizontal/Vertical

- ① Control horizontal/vertical movement using the arrow keys.

(5) Zoom In/Out

- ① Control Zoom using {Wide} / {Tele} buttons.

(6) Focus Control

- ① Control Focus using {Far} / {Near} buttons.

(7) Preset {Set}



Preset? Using horizontal/vertical/Zoom/Focus movement of PTZ Camera, zoom or focus a certain spot of the image by designating the coordinates and move to the designated coordinates quickly.

- ① Move to a desired spot for Preset by using Horizontal/Vertical, Zoom and Focus.
- ② Select 1~15 spots by pressing **{Preset}**.
- ③ Press **{Set}** button to complete Preset setup.
- ④ Repeat ①-③ to another Preset. Up to 15 Preset are available.

(8) Preset {Go}

- ① Select Preset Number by using **{Preset}** button.
- ② Pressing **{Go}** button moves PTZ camera by Horizontal/Vertical, Zoom and Focus movements to the Preset spot that is selected in ①.

(9) Home Position Time

If there are no controlling signals to PTZ camera after a certain time, it goes automatically to the Preset No.1 position as Preset No. 1 is designated as Home Position.

- ① Select **{Home Position Time}** using the arrow keys and the Select button.
- ② Select **{Off/1 minuet /5 minuets /10 minuets /User Setup}** using the arrow keys and the Select button.

(10) Menu

Select Menu button to shift to 1 channel view over PTZ set camera. PTZ Menu is controllable.

Chapter 6. Setup

1-4 3 Time

※ Function Description

1. Time Synchronization

1) Synchronization with the NTP server The time is synchronized every hour with the NTP Server.

A. Automatic Setup

The nearest server from the user's zone will be selected for connection. If the connection fails, the next nearest server will be chosen.

B. User Setup

The user sets the URL or IP for the NTP server. If connection is not established, a message will be sent to the user, and the related log, saved.

If synchronization with the NTP server fails, synchronization with RTC will be established.

3) Synchronization with the DVR Time Server The DTS server is executed in the **DVR system** and the time is synchronized every hour. DTS clients of DVR series referring to the DTS synchronize the time of the DVR system with DTS.

When the DTS time or a zone is changed, the change is reflected on DVR series belonging to the network (the synchronization signals are broadcasted without passing through the router or gateway). The DVR time server does not support automatic connection.

2. Daylight saving time (DST) setup

Regardless of whether NTP server or DST server is referred to, DST is automatically processed according to the time.

3. User time setup

The user can set the time directly.

For the NTP client setup, the user can read the time but not change it.



Move to **{Menu}** **{Setup}** **{Time}** to set up Time Function.

1-4 3-1 Time Sever

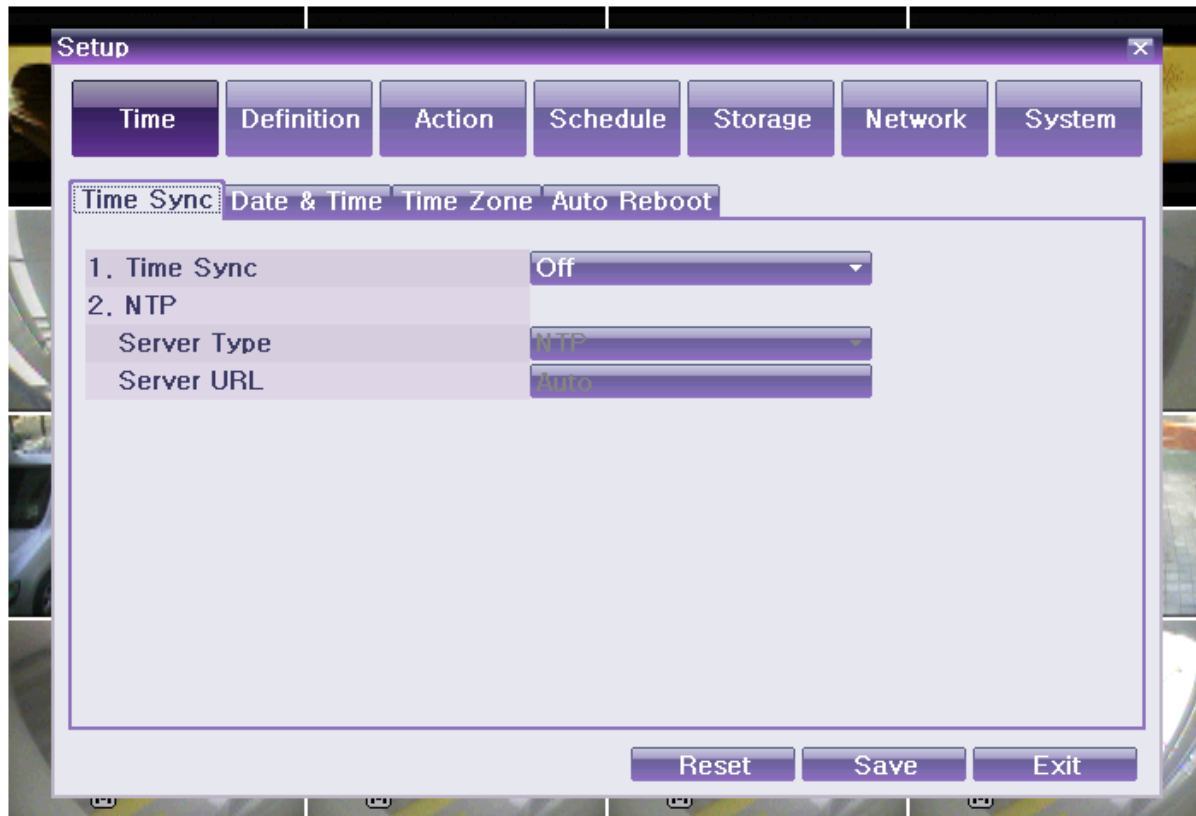

[Figure 6-29. Time Sever]

(1) Time Sever

Off	The time server is not used.
NTP	NTP is used to set the time for the time DVR.

(2) NTP



{NTP} setup is available when {Time Sync} is set as NTP.

(3) Server Type Setup

- ① Select **{Server Type}** using the arrow keys and the Select button.
- ② In the selection box, select the server type using the arrow keys and the [Select] button.

(4) Sever URL

- ① Select **{Server URL}** using the arrow keys and the Select button.
- ② In the selection box, select the server URL using the arrow keys and the [Select] button.
- ③ The user can enter the IP only when the server type is DVR. For the NTP server, Automatic, IP, or URL should be selected.

1-4 3-2 Date and Time

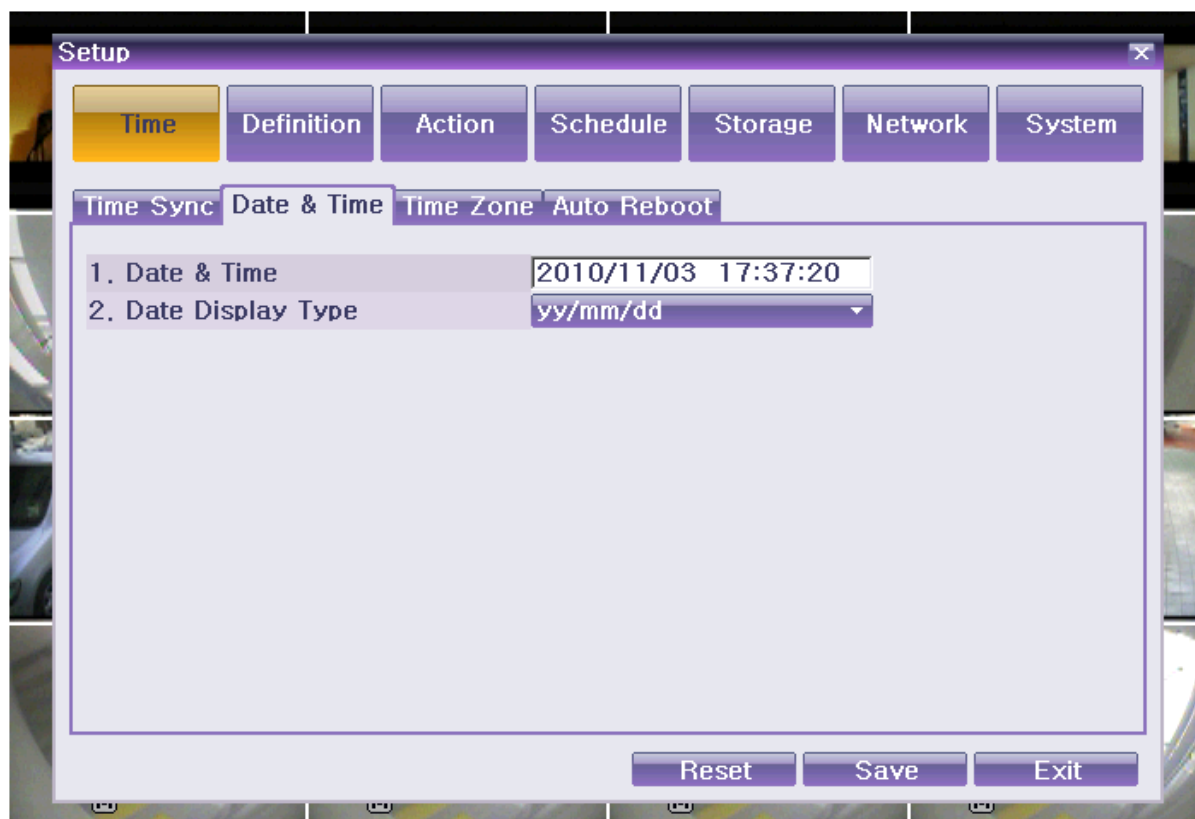

[Figure 6-30. Date and Time]

(1) Date and Time



Only available when Time Server is off.

The system date and time format is Year/Month/Day Hour/Minute/Second.

- ① Using the arrow keys and the Select button, move the focus onto the desired field; Year/Month/Day Hour/Minute/Second and press the Select button.
- ② Select the field you want to change using the arrow buttons and press the [Select] button.

(2) Time Display Format

Select Time Display Format among [Day/Month/Year] / [Month/Day/Year] / [Year/Month/Day].

1-4 3-3 Standard Time Zone



[Figure 6-31. Standard Time Zone]

(1) Standard Time Zone

- ① Select {Standard Time Zone}.
- ② On the selection window, select the standard time zone you want to set.

(2) Summer Time

- ① Using the arrow keys and the Select button, select **{Summer Time}**.
- ② On the selection window, select On/Off using the arrow keys and the Select button.

(3) Start Time

- ① Using the arrow keys and the Select button, select **{Daylight Saving Time}**.
- ② On the selection window, select On/Off using the arrow keys and the Select button.

(4) End Time

- ① Using the arrow keys and the Select button, select **{End Time}**.
- ② On the selection window, set up End Time using the arrow keys and the Select button.



- ※ For a weekly setting in the **{Start Time}** and **{End Time}** fields, set Day to 0.
- ※ After the Daylight Saving Time is selected, the existing data will be displayed as "OLD_" in the search and log list.

1 - 4 3 - 4 scheduled rebooting



- (1) enable by on or off
- (2) Set time of reboot
- (3) Set term of reboot

1 - 4 4 definition



[6-5. Definition]

1-4-4-1 camera

① connect set by on/off



※ if this is set as off, camera input won't be showed regardless of its connectivity.

② name set name up to 20 character.

③ covert

set live not to be showed for privacy reason.



※ yet recording goes on.

④ Adjust

Adjust brightness, contrast, hue, saturation, sharpness.
Adjust camera margin.

1-4-4-2 PTZ Set PTZ camera.

PTZ camera need to be connected to DVR. Refer to [2-3-2] [4] PTZ camera. {menu} {setup} {Definition} {PTZ}

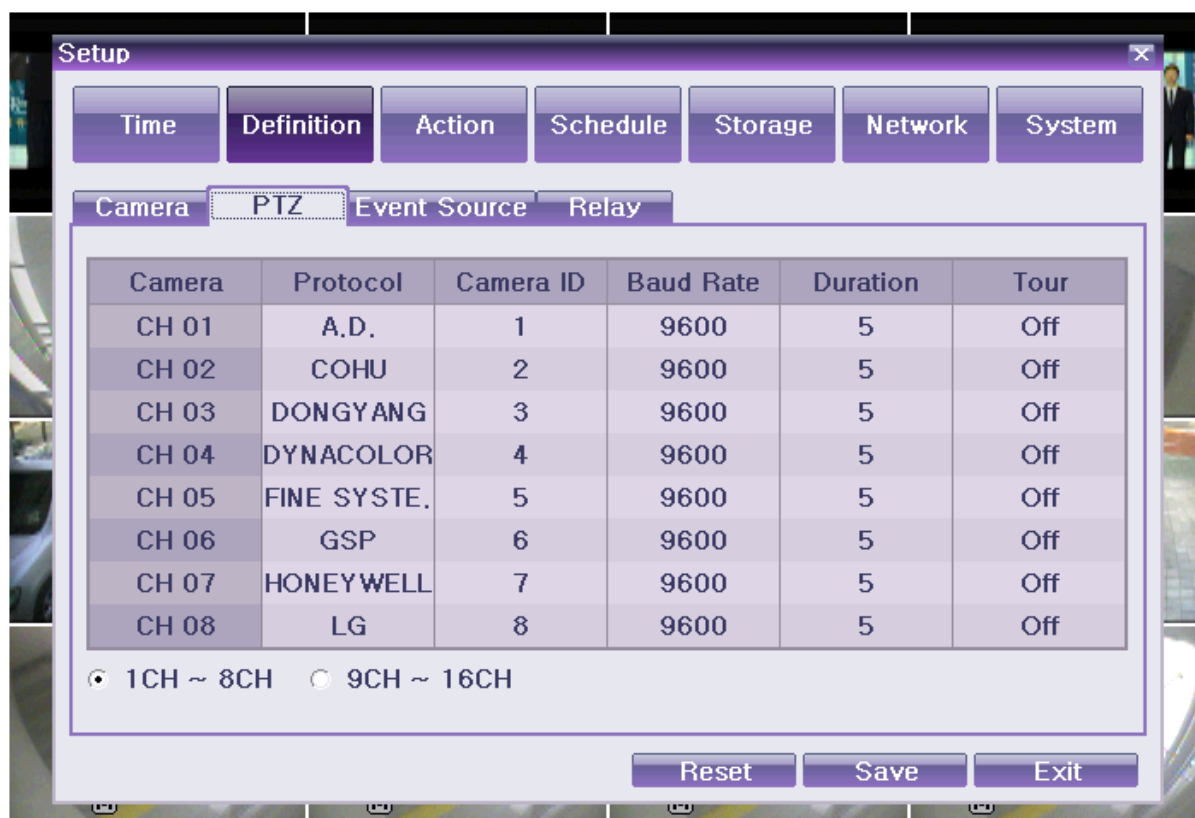

[6-6. PTZ]

Camera	1 ~ 16 channel
Protocol	Set PTZ protocol
Camera ID	PTZ camera ID
Baudrate	Match camera's baudrate
Duration	Mean time between presets of tour (5 ~60 seconds)
Tour	Set tour 1 or tour 2

Set PTZ protocol

- ① Set recommended PTZ protocol by camera manufacturer. 22 manufacturers supported.

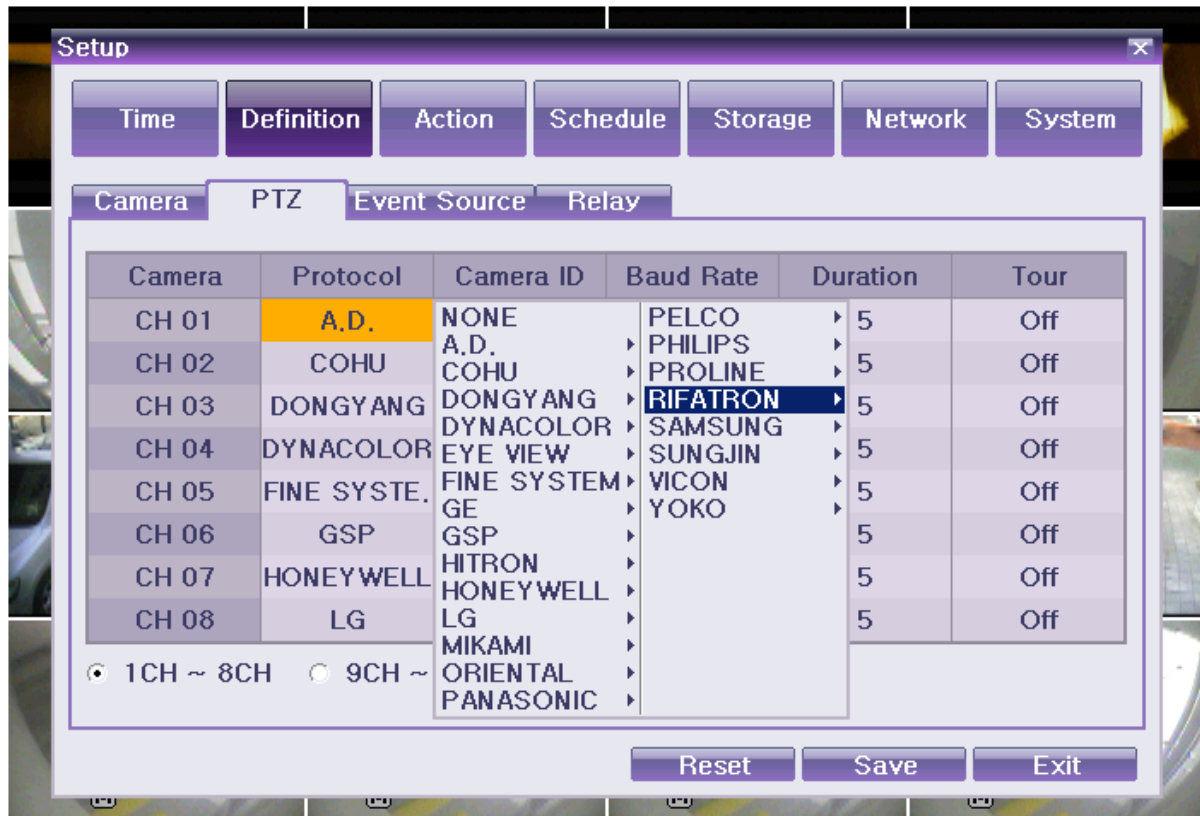

[6-7. PTZ protocol]

- ② choose PTZ protocol.

(2) camera ID

set camera ID.

	<ul style="list-style-type: none"> ※ match camera ID of DVR and camera ID of PTZ camera. ※ consult camera manufacturer's manual
--	---

- ① click camera ID
- ② set camera ID in popup window

(3) Baud rate

transmission speed to PTZ camera

	※ set baud rate of DVR the same with baud rate of PTZ camera ※ please refer to PTZ camera's manual to set its baud rate
---	--

- ① click baud rate
- ② set baud rate in popup window

(4) duration

to set meantime between presets of tour(5 ~ 60secs)

- ① click duration
- ② set duration in popup window

(5) tour

Automatically Pan Tilt Zoom from a preset position to another preset position

- ① Choose tour1 or tour2. Each can contain up to 15 preset position

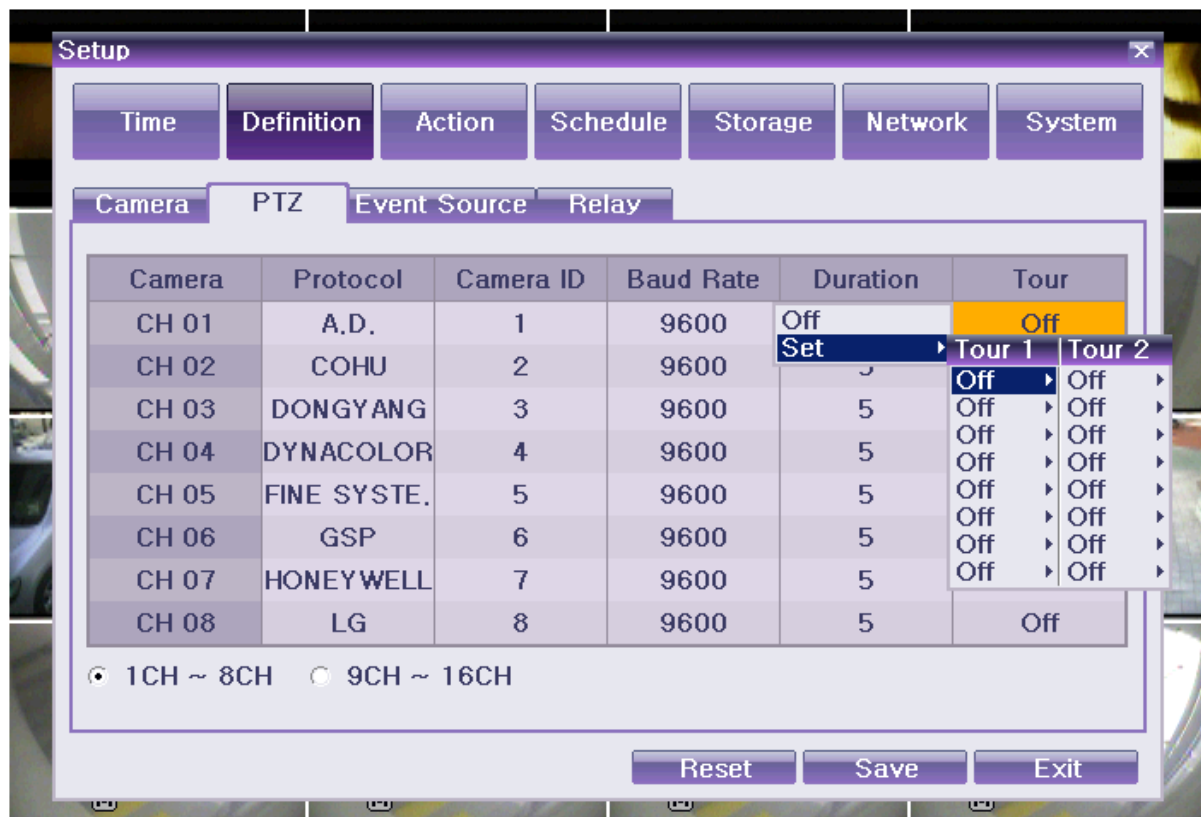

[6-8. PTZ tour]

- ② Set tour in popup window

1-4 4-3 Event Source

{menu} {setup} {Definition} {Event Source }

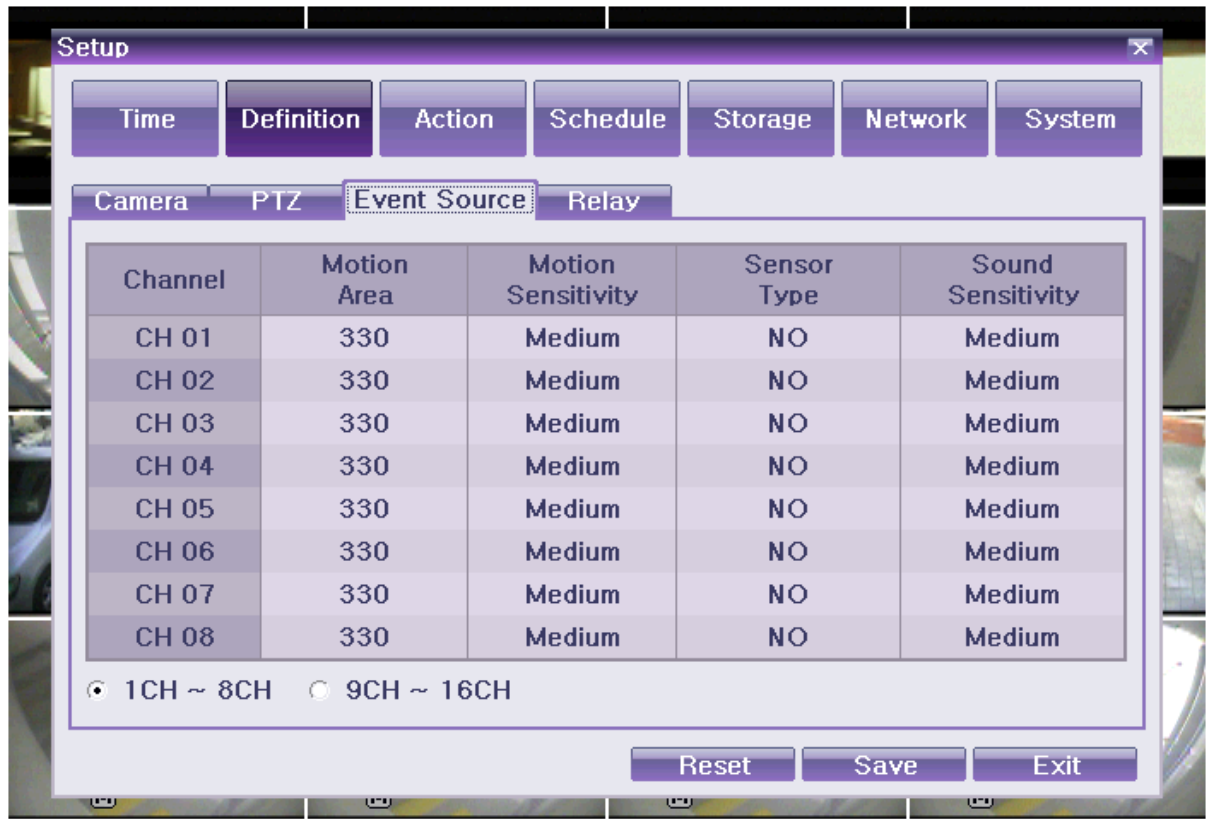

[6-9. Event Source]

(1) Motion Area

Set motion detection enabled area

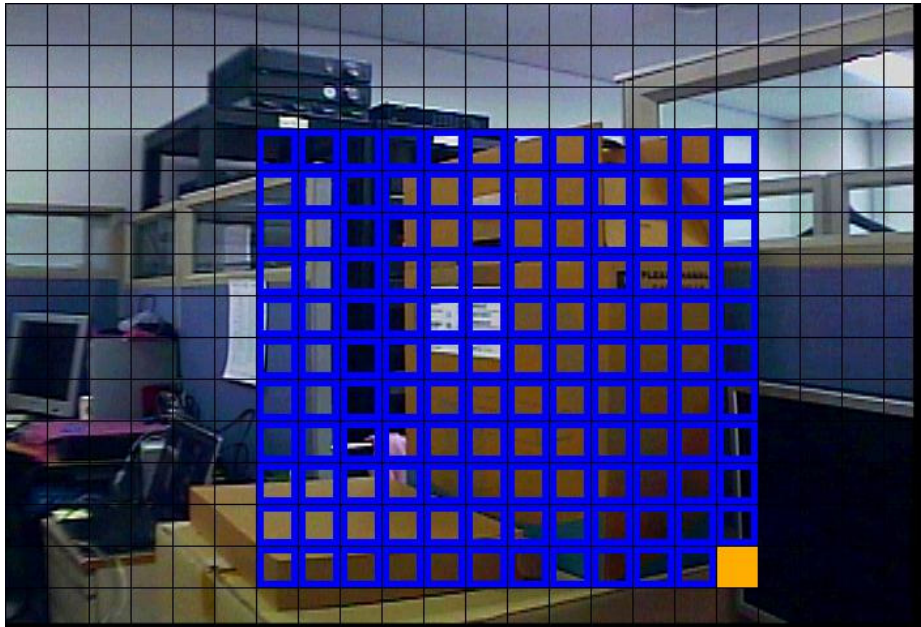

[6-10. Motion Area]

- ① Click Motion Area
- ② Drag and drop orange square. Browned area will be disabled of motion detection
- ③ exit

(2) Motion Sensitivity

Set motion detection sensitivity by {lowest} / {low} / {medium} / {high} / {highest}

What sensitivity mean?	
------------------------	--



(3) Sensor Type

Set NC or NO.



(4) Sound Sensitivity

Set audio detection sensitivity by {lowest} / {low} / {medium} / {high} / {highest}

1-4 4-4 relay
set relay



[6-11. relay]

1-4 5 Action

Set recording, system, main features. {menu} {setup} {Action}

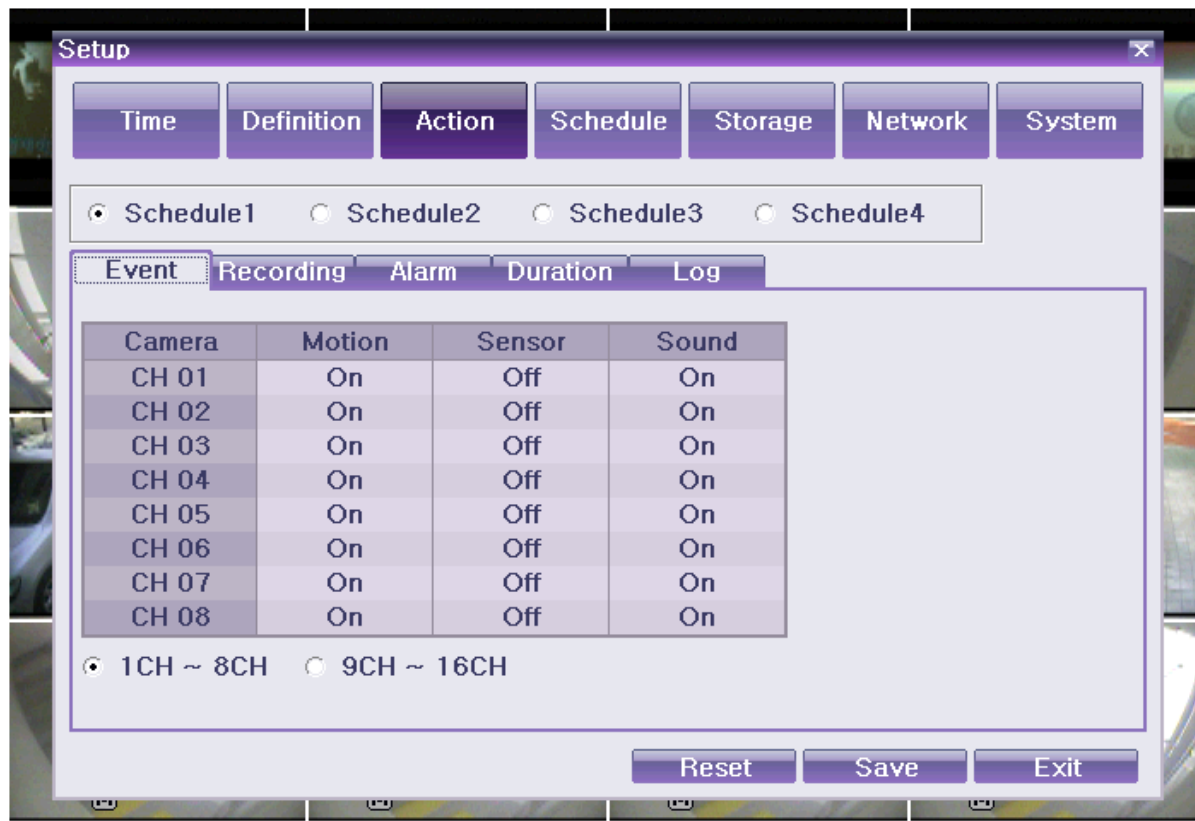

[6-12. Action]

1-4 5-1 schedule (schedule1 - schedule4)

- ① 4 different settings can be applied by time and date on schedule table for user convenience. Please go to menu/schedule after setting up schedule1, schedule2, schedule 3, schedule 4 differently.

1-4 5-2 event

On / Off motion, sensor, audio

	Description
Continuous	Record in accordance with Normal Speed.
Motion	Record in accordance with event speed when motion detected
Sensor	Record in accordance with event speed when sensor activated
Sound	Record in accordance with event speed when sound detected

1-4 5-3 recording

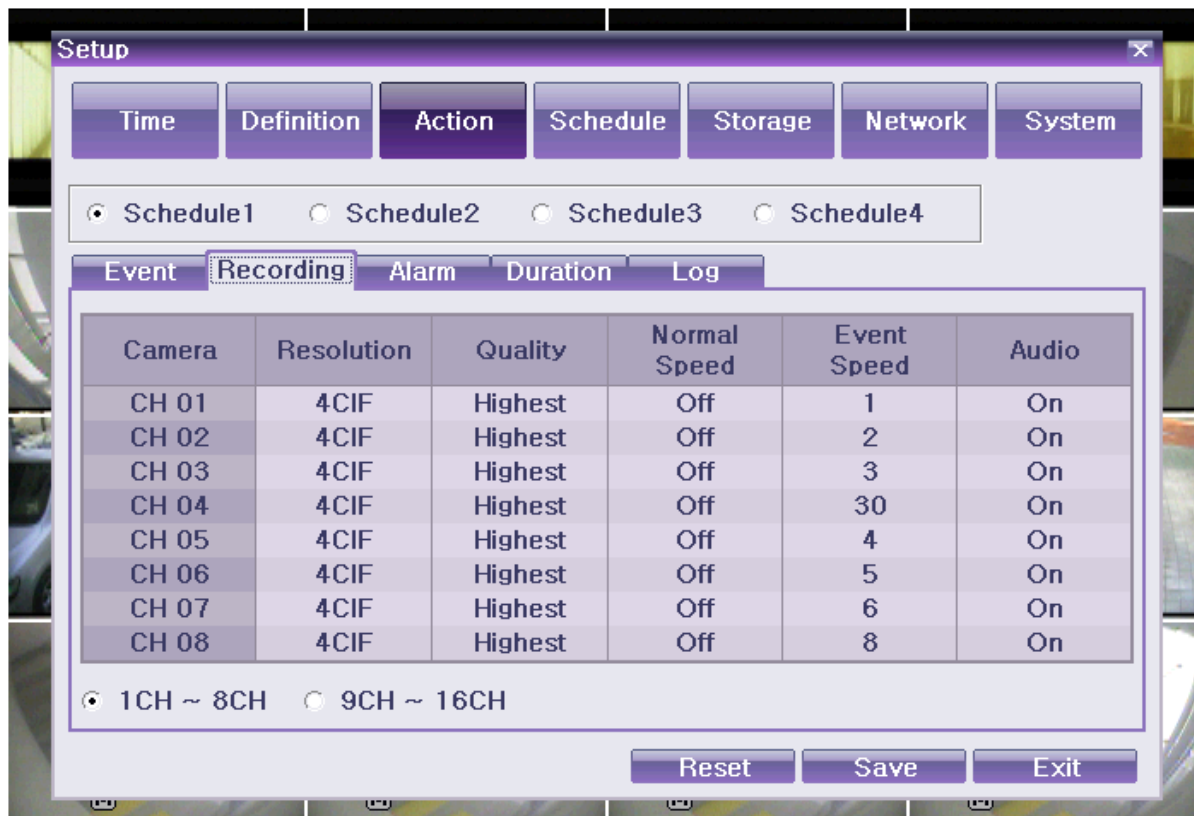

[6-13. recording]

(1) resolution

Set resolution

	NTSC	PAL
CIF	352 × 240	352 × 288
2CIF	704 × 240	704 × 288
4CIF	704 × 480	704 × 576

(2) quality

Set quality by {lowest} / {low} / {normal} / {high} / {highest}

	* files size is in direct proportion to quality
--	---

(3) normal speed, event speed

Set frame per second of recording by continuous mode, motion detection, sensor activation, audio detection

Normal Speed	When record continuously
Event Speed	When record by motion, sensor, audio

	CIF (NTSC/PAL)	2CIF (NTSC/PAL)	4CIF (NTSC/PAL)
16channel	480/400fps	240/200fps	120/100fps
8channel	240/200fps	120/100fps	60/50fps

- ① sum of fps designated in each channel can't be exceeded maximum capacity in the table above.
- ② if maximum fps in the table above exceeded, table of [6-14] will automatically adjust itself not to exceed its capacity.



[6-14. Adjustment of FPS]

(4)Audio

enable/disable audio input

1-4 5-4 Alarm

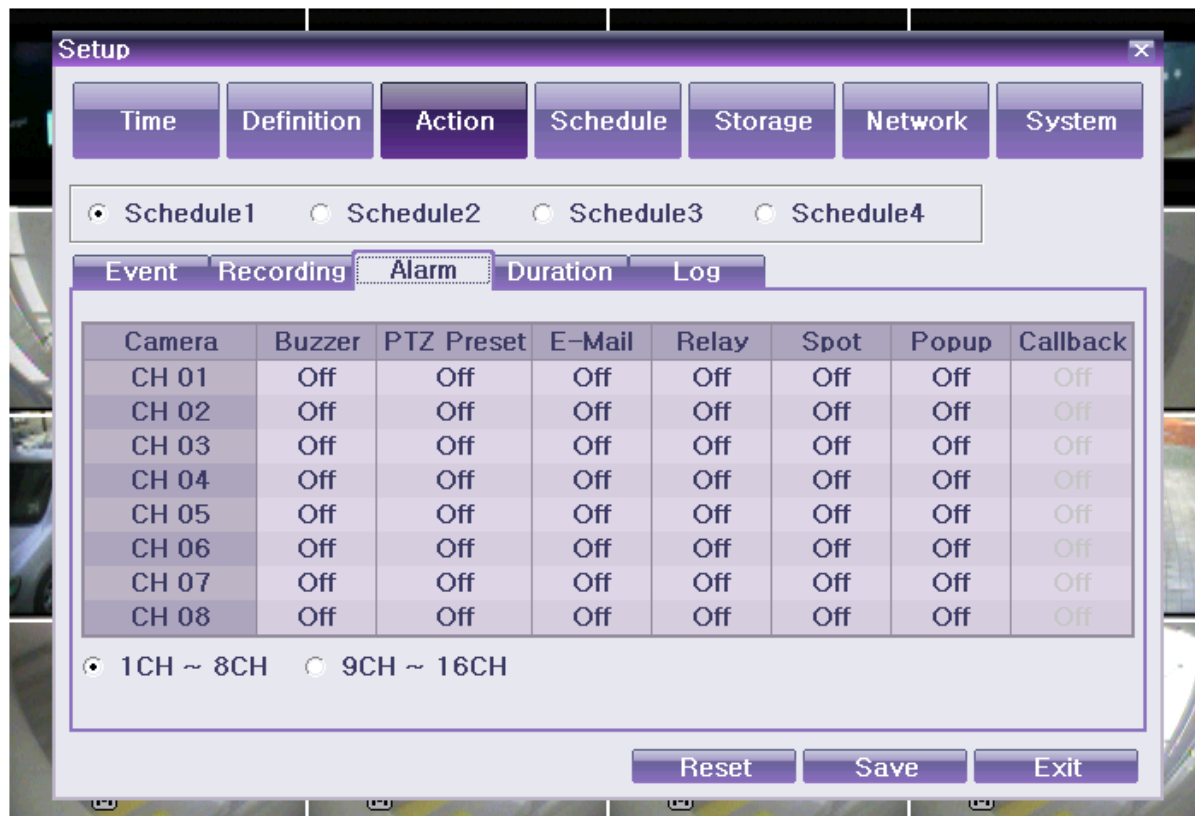

[6-15. Alarm]

※ set alarm option of PTZ preset / email / relay / spot / popup.



※ popup function show warning when event occur.

1-4 5-5 Duration

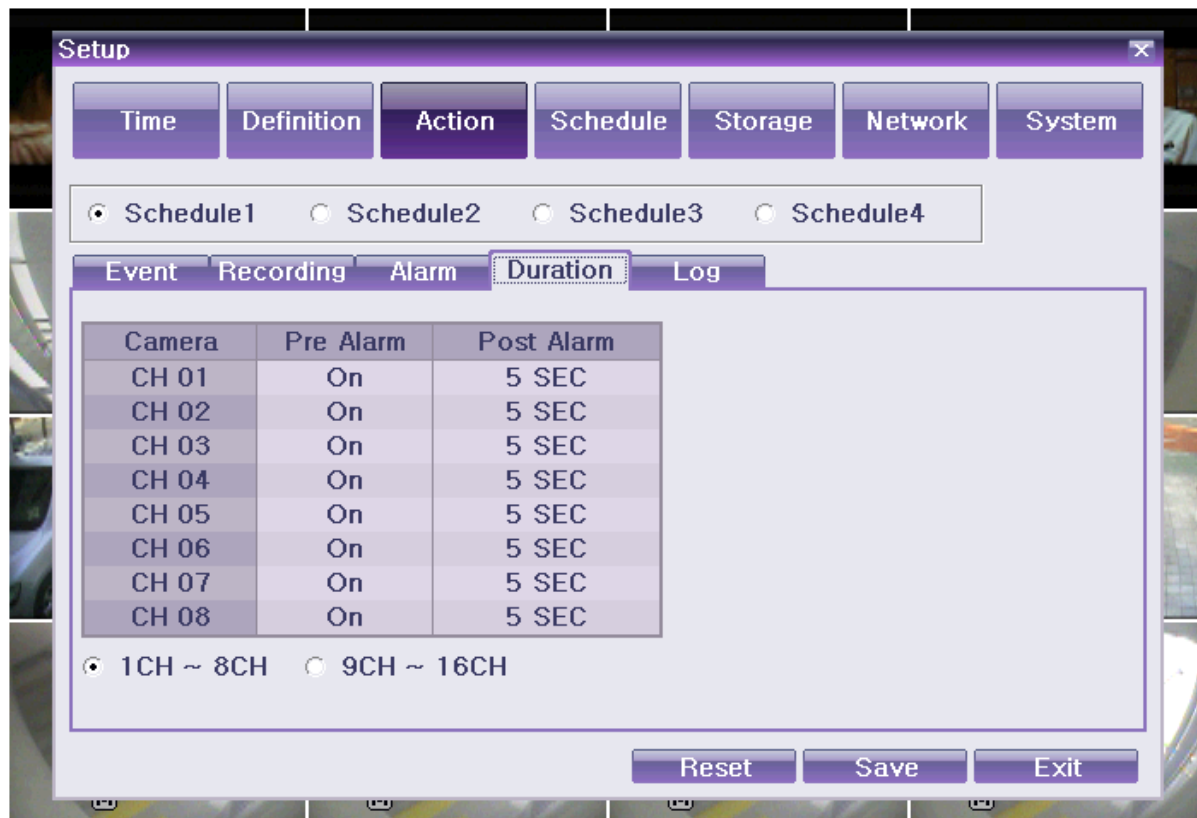

[6-16. duration]

Pre alarm(On / OFF), post alarm(5sec / 10sec / 15sec / 20sec / 60sec / 150sec / 300sec)

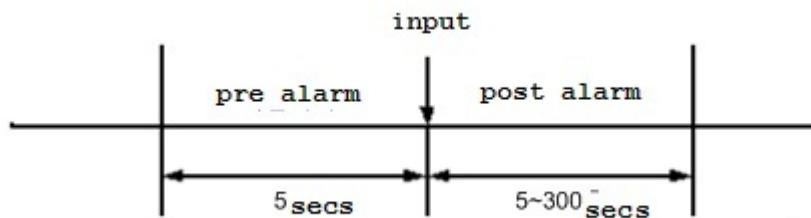

[6-17. pre/post alarm]

1-4 5-6 log

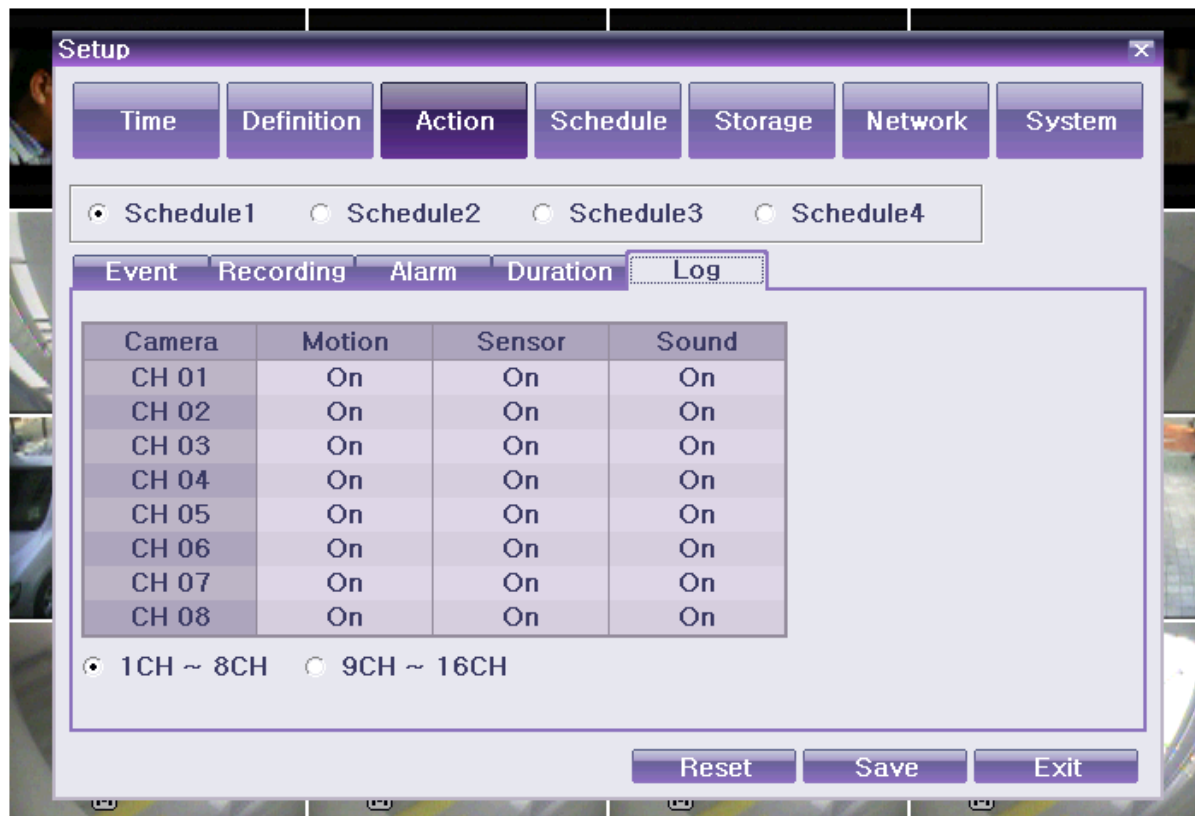

[6-18. log]

On/off of log by motion detection / sensor input / sound detection

1-4 6 **Schedule**

{Schedule} is used to save the system configuration as data from **{Schedule 1 ~ 4}** and to make a recording based on the system configuration for each day/time zone.

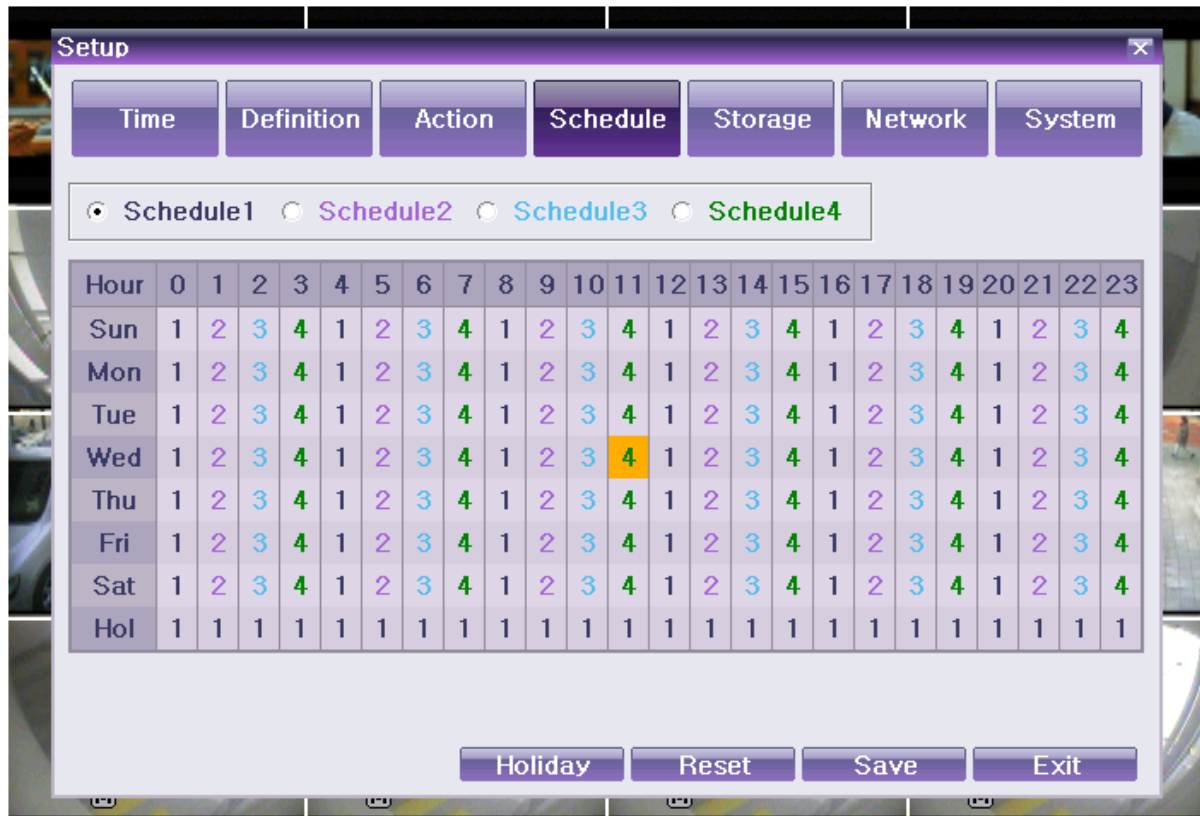

[Figure 6-32. Schedule Window]

1-4 6-1 Enter to Schedule Menu

- ① Select {Menu} {Setup} {Schedule}.
- ② Recording Schedule Window appears as shown in [Figure 6-42].

1-4 6-2 Schedule Setup

(1) Set a line(Left to Right)

- ① Select the date and time to be set using the arrow keys.
- ② Select a schedule to be set.
 - a) Pressing (or double-clicking) the Select button causes only the selected date and time to be set.
 - b) Select (or right-click) the Menu button to make the setting for all time zones after the selected date and the time zone.
- ③ On the selection window, set the schedule using the arrow keys and the Select button.

(2) Set a line(Top to Bottom)

- ① Go to the top of the time column using the arrow keys.
- ② Select the schedule to be set.
 - a) Press (or double-click) the Select button to set only one column.
 - b) Select (or right-click) the Menu button to make the setting for all time zones after the selected time zone.
- ③ On the selection window, set the schedule using the arrow keys and the Select button.

(3) Holiday Registration

This feature is used to enable the user to set the holidays.

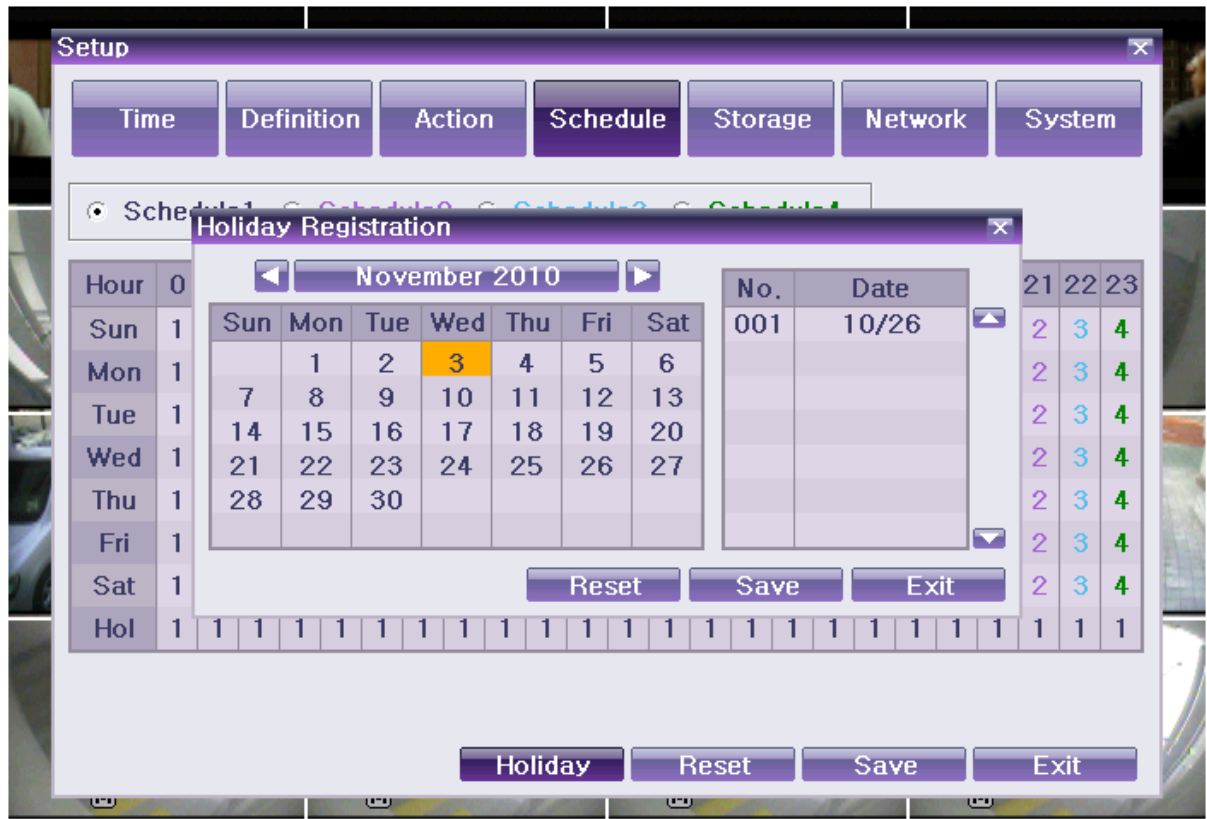

[Figure 6-33. Holiday Registration Window]

 If the date for the holiday and day of the week are the same in the **{Schedule}** menu, the holiday setup will have priority over the date setup.

Ⓐ Calendar

The defined holidays will be indicated with a red tag.

Ⓑ Holiday List

The list of all defined holidays will be displayed.

A total of 7 holidays will be displayed per page, and the rest, on the following pages.

Ⓒ Holiday Information

{ No. } is the holiday number arranged by date.

{ Date } shows the date of the holiday.

① Select **{Schedule}** **{Holiday}**.

② On the Holiday Registration Window, select the date using the arrow keys and the Select button and press the Select button.

③ After setting the holiday, press the **{Save}** button at the bottom of the menu. Afterward, press the [Select] button.

1-4 7 Storage

Select **{Menu}** **{Setup}** **{Storage}**.

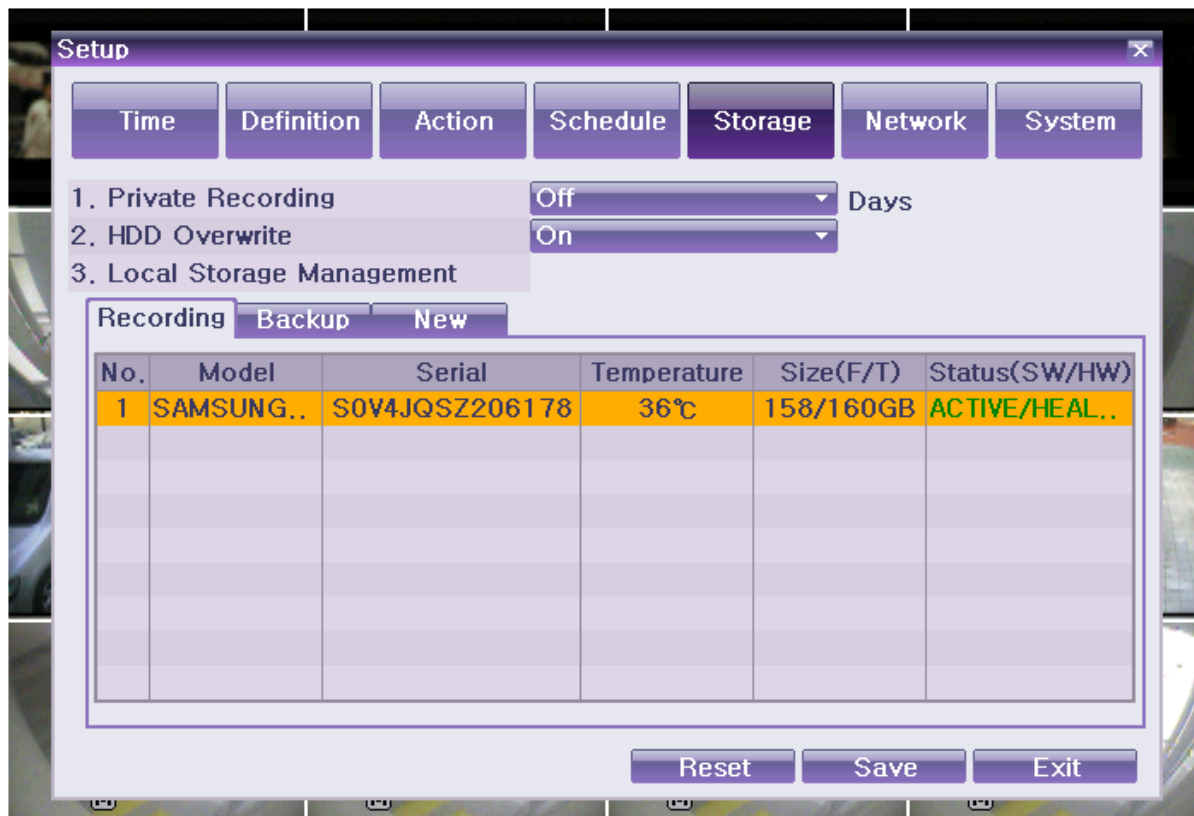

[Figure 6-34. Storage Window (Local)]

	<p>To apply the new setting, save the new setting. Initialization: initialize the menu as the basic setting. Save: Saves the setting data. Exit: Ask if the user wants to save the setting data.</p>
--	--

1 - 4 7 - 1 Max. Recording Days

This is to limit the recording days. You can set None/1day/7days/30days/User setting(1-31).

1 - 4 7 - 2 HDD Overwrite Set On/Off for HDD Overwrite.

- ① Select On/Off for HDD Overwrite.

On	If there is no more hard disk space left, the existing files will be overwritten starting with the oldest.
Off	If there is no more hard disk space left, further recording will not be executed.

Local Storage Management

- ② Local Storage is classified and managed as three parts; **{Direct}**, **{Backup}** and **{New}**.

(1) Local Storage Management Function

Local Storage refers to the internal hard disk and storages connected to the system via USB. Local Storage is classified and managed as **{New}**, **{Direct}** and **{Backup}**, and functions are described below.

① **New**

For SVR series, all storages, initially detected are managed in **{New}**. All initially detected storages are displayed as New and can be changed into Storage or Backup.

Direct Initialize	Changes the selected storage into a dedicated (Direct) storage.
Backup Initialize	Changes the selected storage into a backup storage.



In **{New}**, At least, one storage shall be selected as a dedicated storage. Otherwise, the data cannot be stored in real time.

② Recording

The saving(Recording) storage is managed in Recording. The saving(recording) storage stores data on the hard disk in real time. Five commands can be executed. Depending on the S/W status, however, some commands cannot be executed.

New	Returns the status of the selected storage device to New; if this command is executed, the selected storage device will be moved to the {New} storage device manager.
Online	Changes the selected storage device in online state.
Offline	Changes the selected storage device in offline state.
Format	Format the selected storage.
Eject	Separates the selected device completely from the software.

	Physical states supporting the execution of the commands above include Healthy and Warning. In fault state, however, no command can be executed.
---	--



When removing a hard disk installed in the DVR or storages connected to USB port, the user shall execute the **{Eject}** command.

③ Backup

The backup storage is managed in Backup. Backup storages are not used to store data; rather, they are only used to back up data. The user can execute only the **{New}** command.



Depending on the storage type, the storage is used only for (Direct) or (Backup) purposes.

(2) Configuration of the local storage device

Model	Model name of the storage device
Serial	Serial number of the storage device
Location	Physical location of the storage device
Capacity(T/F)	Storage device capacity (T: Total; F: Free)
Status(SW/HW)	Storage device status (SW: Software; HW: Hardware)

	※ There are three software status types.
Active	Connected to storage or backup device; currently saving the data.
Online	Only connected to storage or backup device.
Offline	Not connected to storage or backup device.

	※ There are three hardware status types.
Healthy	Connected to storage or backup device; functions normally.
Warning	Connected to storage or backup device, but error was detected; in this case, data storing or backup cannot be made (for more information, see the description below).
Fault	Not connected to storage or backup device; cannot perform data saving or backup.

1. **Fault State** : The storage device is completely damaged, and none of the S/W operations can be performed. The fault state is not related to a DVR problem. The DVR has detected the fault and stopped the recording.



2. **Warning State** : The storage device has a physical error that can be corrected by the storage device or by the DVR. If the error is not taken care of, however, the storage device is likely to be damaged (and shift to fault state). Backing up data in the corresponding storage device and replacing the device with a normal one are strongly recommended.
3. If there is an active storage device with a warning or a fault, a message is displayed on the upper left part of the screen.

(3) Operation after adding a local storage device

- ① Open the system body and install a new disk (connect the data cable and the power cable).
- ② Connect power to the system and boot the system.
- ③ Select **{Menu} {Setup} {Storage}** using the arrow keys and the Select button.
- ④ A newly displayed disk will then be displayed as **{New}**.
- ⑤ Select a newly installed disk using the arrow keys and the Select button and initialize the disk as a **{Direct}** or a **{Backup}** disk. The following describes the method of setting the saving(direct) storage.

※ **Selecting {Direct-Init} or {Backup-Init} causes all data in the device to be erased. Therefore, caution is required.**

※ **While {Direct-Init} or {Backup-Init} is being set up, do not remove the device (may cause an error when detecting the device).**



※ **To use the external or portable storage device for system upgrade, set to {Backup-Init} in the {New} item for {Main Setup} {Storage Device} {Local Storage Device Management}.**

※ **When used in DVR equipment for the first time, a backup USB device will always be detected in the {New} category. Therefore, a USB device in the {New} category must be set up as {Backup-Init} prior to use for backup. A USB device that has gone through this procedure will be detected in the {Backup} category when used again in the DVR equipment.**

- ⑥ **{Direct}** shows the status of the newly installed disk online.

(4) Direct HDD Format

- ① Select the desired model in **{Menu} {Setup} {Storage}** and the window as shown below appears.

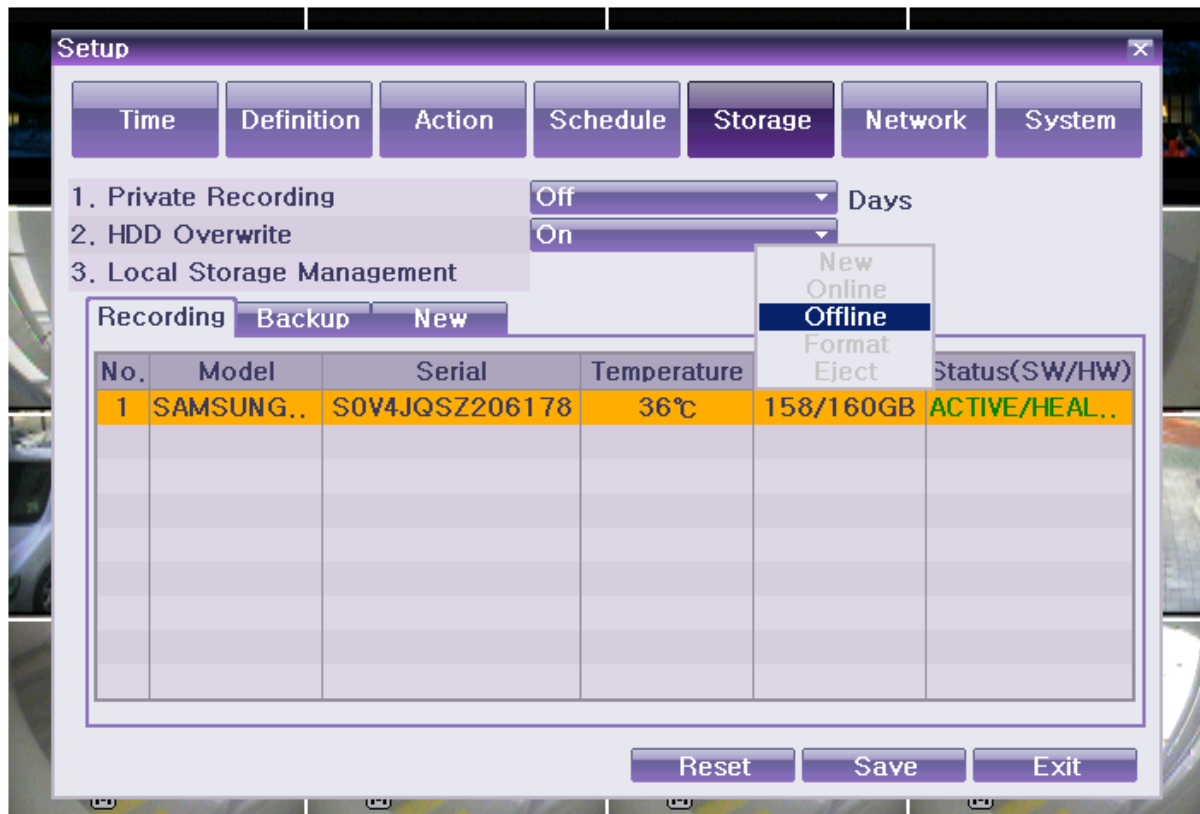

[Figure 6-35. Storage Offline]

- ② Select Offline and select the model as shown below.

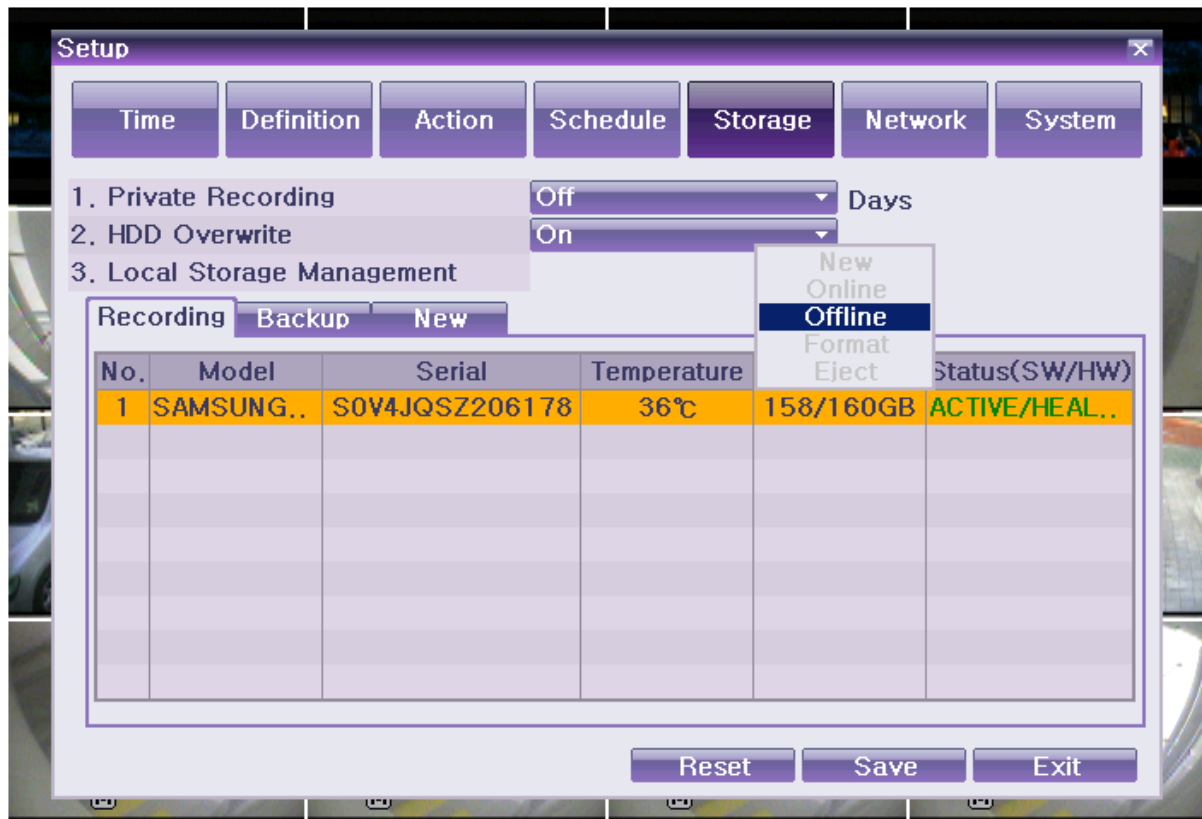

[Figure 6-36. Storage Format]

- ③ Then, the user is able to choose [New/Online/Format/Eject]. Select Format and formatting progress as shown below.

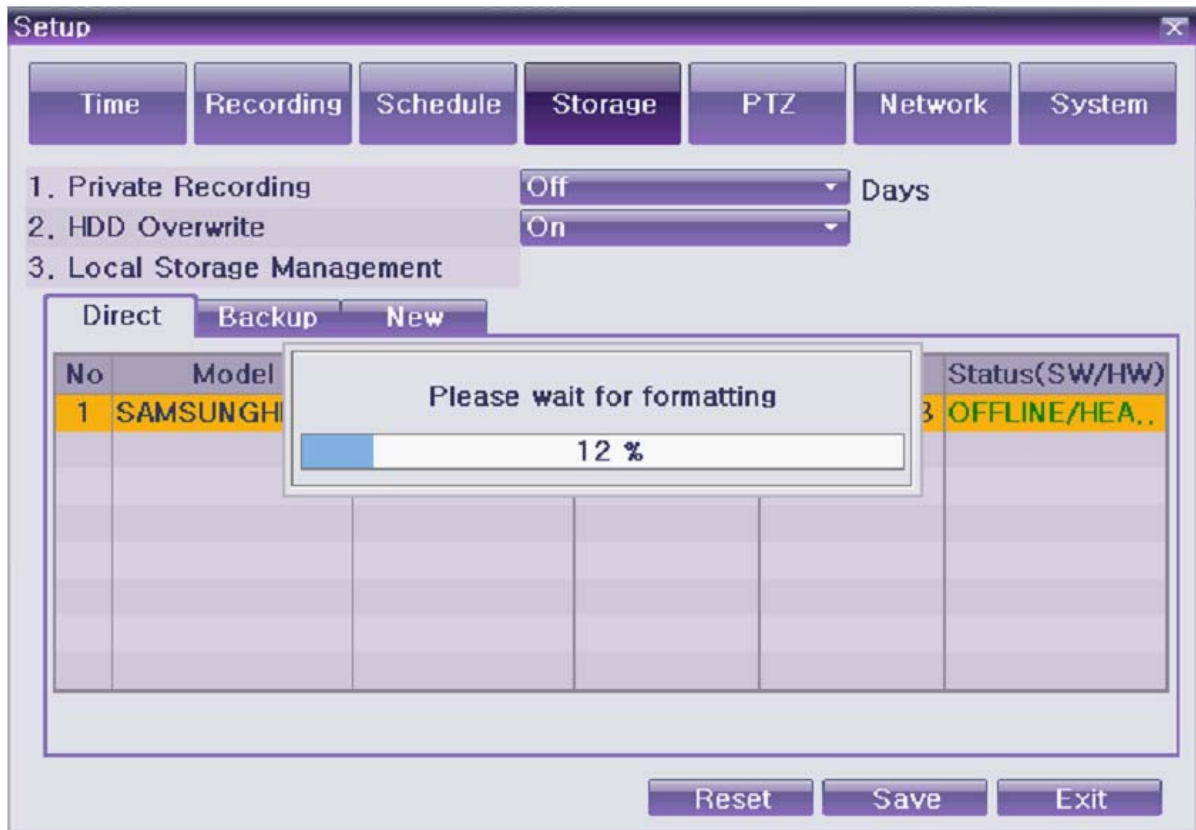

[Figure 6-37. Storage Formatting Message in progress]



It may take time during formatting.

- ④ After formatting, select the model again and set as Online.
- ⑤ Format is completed.

1 - 4 8 Network

Set the system network. {Menu} {Setup} {Network}.

1 - 4 8 -

1 Ethernet (1) TCP/IP

Setup is performed to use a fixed IP in the Local Area Network environment.



[Figure 6-38. Setup Network Window]

- ① Select **{Ethernet}** in **{Menu}** **{Setup}** **{Network}**.
- ② Select **{TCP/IP}**.
- ③ Save after filling in IP Address, Subnet Mask, Standard Gateway, Standard DNS, and Alternative DNS.

(2) ADSL

This feature is used in the user authentication-type ADSL communication environment.

- ① Select **{ADSL}**.
- ② Save after filling in User Name and Password.

1-4 8-2 DDNS

As part of the DNS system, the Dynamic Domain Name System (**DDNS**) service updates the IP addresses of host names in real time and allocates fixed domain names to systems linked to dynamic IP addresses to allow users to use the same DNS name regardless of the changes in the IP address. It provides dynamic DNS to ensure URL access in the dynamic IP environment.

User can monitor the remote place thru internet with web server functions which is equipped in DVR.



[Figure 6-39. DDNS Window]

- ① Select **{DDNS}** in **{Menu}** **{Setup}** **{Network}**.
- ② Select On/Off of DDNS or a domain name to use using arrow keys and the selection button.
- ③ In case of DDNS On, enter the host name and save it then, the registration procedure of the host name proceeds automatically. You can enter the host name with 4-20 letters.
- ④ The host name to enter must not be pre-registered in DDNS sever. Otherwise it won't work.
- ⑤ The basic host name is the MAC address of appertaining DVR.
- ⑥ In case the host name have entered starts with "000c28", none of MAC address will work excepting for appertaining DVR's.
- ⑦ In case of DynDNS On, enter the host name, user name set in the server and password then, save them.

	<p>※ Access to DynDDNS sever(http://www.dyndns.org) and apply for the user account then, register the domain name to use and enter URL.</p> <p>※ For more information, please access to the sever.</p>
---	--

1-4 8-3 Port

This feature is used to set up the user for the network port.

The default value is between 2000 and 2007; a randomly chosen value can be used depending on the network environment. The Web Server Port is used to connect the DVR remote monitoring. The default value is 80 and a random number over 2000 may also be used.

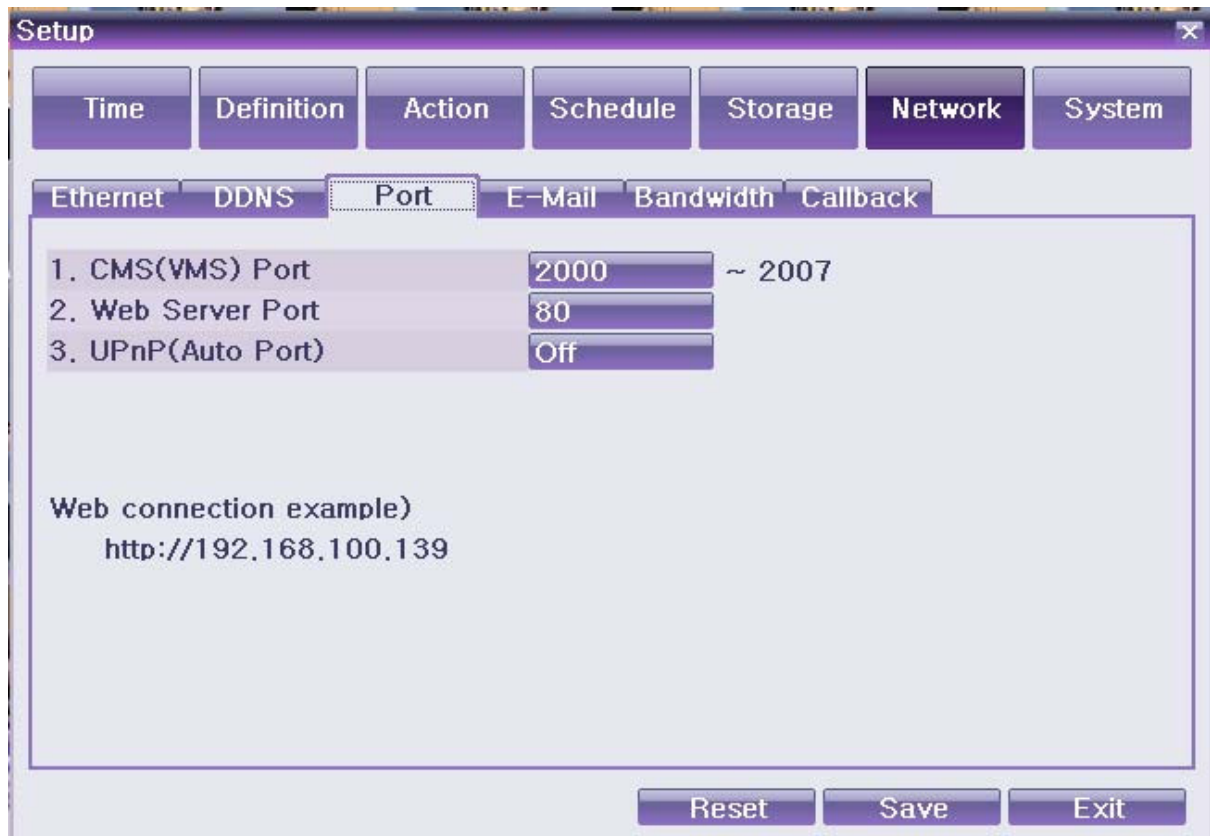

[Figure 6-40. Port Window]

- ① Select **{Port}** in **{Menu}** **{Setup}** **{Network}**.
- ② Save after entering each port number.
- ③ UPnP function will be available on the selection of On. On UPnP, 'Success' will be popped up on the port registration at Router. Otherwise, 'Failure' will be popped up instead.

1-4 8-4 E-mail

Automatic E-mail transmission service when an event occurs.

To use the e-mail function, {E-mail} in **{Menu}** **{Setup}** **{System}** **{9. Alarm}** and DNS or sub DNS in **{Menu}** **{Setup}** **{Network}** **{Ethernet}** need to be configured.

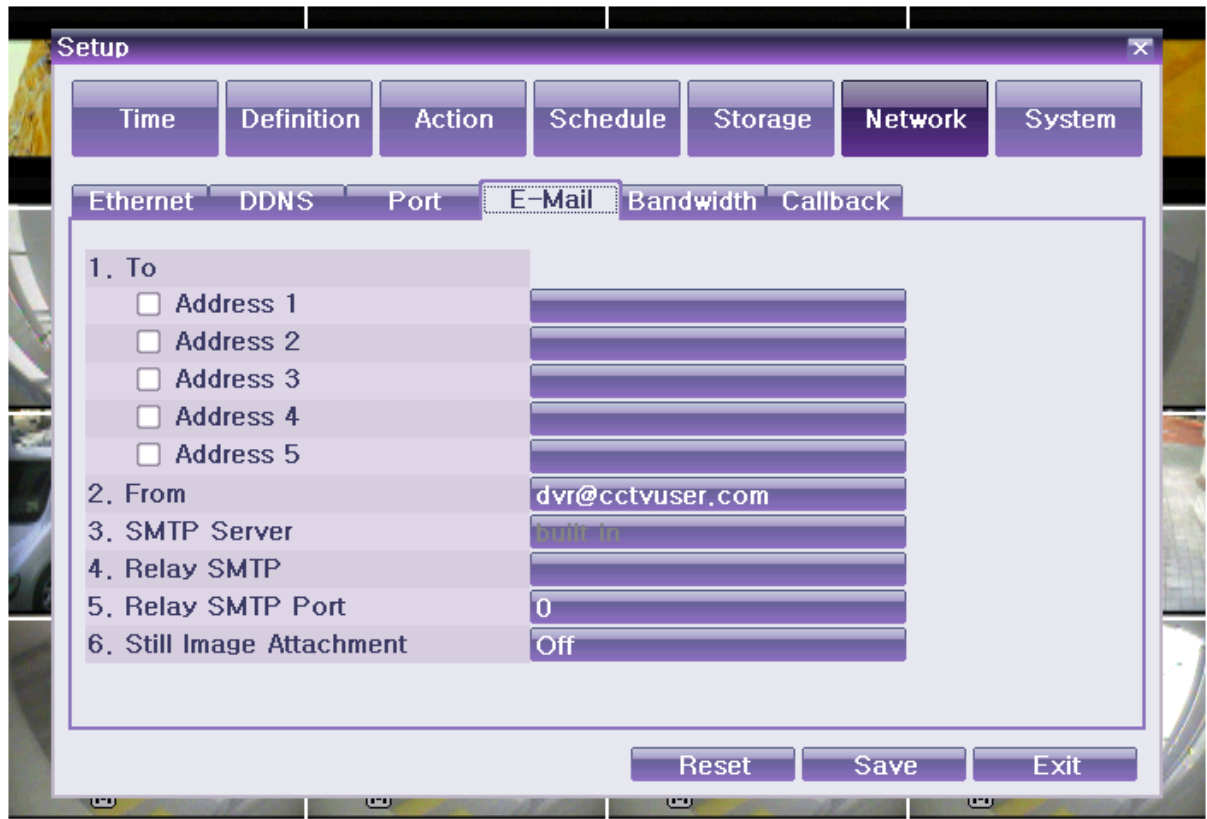

[Figure 6-41. E-mail Window]

- ① Select {Menu} {Setup} {Network} {E-mail}.
- ② Save after entering the detail about E-mail.

1-4 8-5 Bandwidth

This sets up the limit of the bandwidth to be used when bringing the live image, adjust resolution/quality and transmitting the data by using the network.

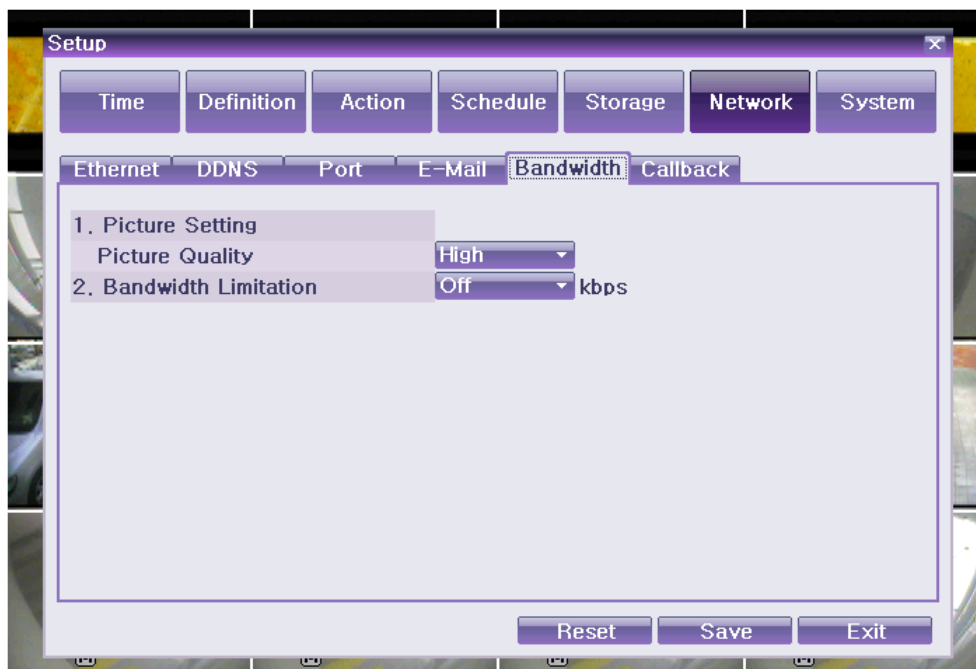

[Figure 6-42. Bandwidth Window]

- ① Go to {Menu} {Setup} {Network} {Bandwidth}.
- ② Save after entering the detail.

Image Quality	Adjust quality of the image, as the value increases, the compression rate gets higher and image quality gets low. However the transmission rate gets higher.
Bandwidth Limit	You can set the network bandwidth between 40 ~ 4000kbps. As the value increases, the network transmission speed gets faster. Select Off if you do not wish to limit the network bandwidth.

1 - 4 9 **Callback**

The signal is transferred to callback server for auto-recording when there happens an event at the site.

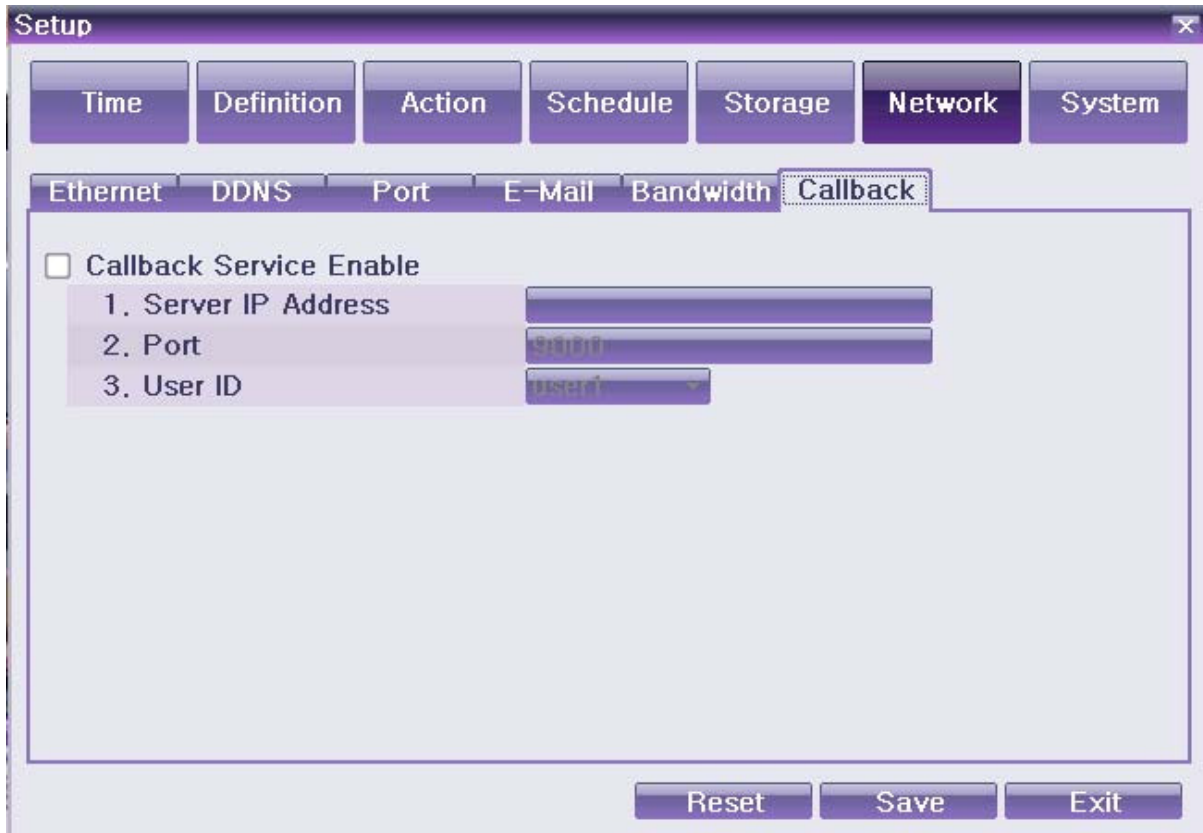

- ① Check-box for call back service should be checked.
- ② Set up Callback server IP, Port No, User ID for auto log-in.
- ③ Callback server IP could be entered directly or through URL
- ④ Port no. should be 31000.
- ⑤ User can be selected at the menu {Setup} -> {System} -> {4. users}.

1 - 5 0 **System**

In {Menu} {Setup} {System}, the user can configure the system and the auxiliary features of the system.

1. DVR Name	Used to name the DVR device.
2. ID For Remote Controller	Used to name the remote controller for running the system.
3. ID For Key Controller	Unique system controller number setting.
4. User Registration	Used to register, add, or delete users.
5. Admin. Password	Used to set the password of the Local System Administrator.
6. Upgrade	Upgrades the system firmware.

7. Factory Setup	Initialize Setup.(Factory default value, except for the network value)
8. RS232C Port	Use of the RS232C port.
9. Alarm Action	Set the alarm On/Off and alarm format.
10. Alarm Duration	Set the alarm time by continuous/5/10/15/User Setup.
11. Menu Time Out	Used to set the time for exiting the System Setup menu automatically and displaying the real-time monitoring screen.
12. Language	System OSD language setting

1-5 0

- 1 System Menu

① Select **{System}** at **{Menu}** **{Setup}**.

② System Setup Window, as shown below, appears.



[Figure 6-43. System Setup Window]

1-5 0

- 2 DVR Name

① Move to **{Menu}** **{Setup}** **{System}** **{1. DVR Name}**.

② Enter the name in the input window using the arrow keys and the Select button. The initial value is Mac address. (It supports up to 20 letters for the system name.)

1-5 0

- 3 ID for Remote Controller

When multiple devices are used, set the remote controller ID to identify input signals from a remote controller. **(SVR-series only. Other series do not support this function.)**

	Only the system that DVR ID and remote controller ID match can receive input signals from the remote controller as shown below.
---	---

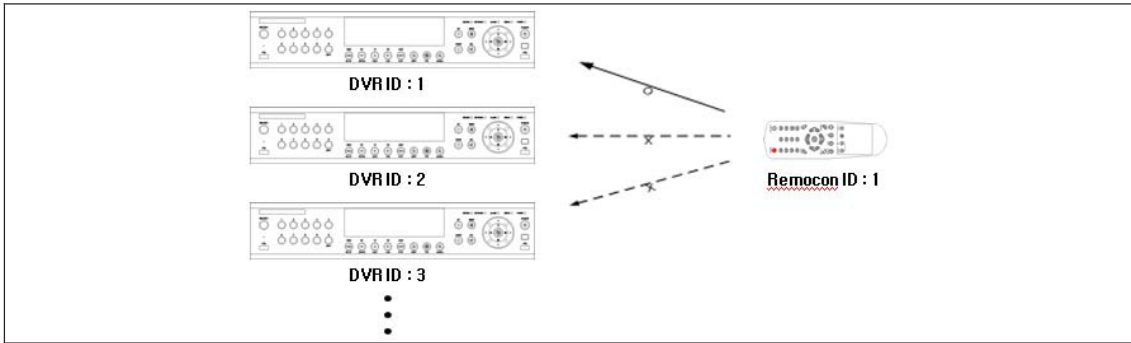

- ① Move to **{Menu} {Setup} {System} {2. Remote Controller ID}**.
- ② In the selection window, enter ID using the arrow keys and the Select button (the number 0~99 is available for ID.)

	If you forgot the DVR ID, set the remote controller ID to 999 to start the DVR. Note, however, that the DVR ID should be the same as the remote controller ID.
	<p>※ To Configure Remote Controller ID (Example: ID setting as 3)</p> <ol style="list-style-type: none"> 1) Press {ID} button on the remote controller. 2) Press the {0} key and {3} key. 3) Press {ID} button again. 4) Remote Controller ID is set as 3.

1 - 5 0

- 4 ID For Keyboard Controller

- ① Move to **{Menu} {Setup} {System} {3. ID for Key Controller}**.
- ② In the selection window, enter ID using the arrow keys and the Select button (the number 1~255 is available for ID.)

1 - 5 0

- 5 User Registration

Adds, edits, or deletes the users who will operate the system.

System Access Authorization	
Network Live	Enable viewing real-time images upon network access.
Playback	Enable viewing the Recorded Screen.
Copy (download)	Copy and download files.
PTZ camera	PTZ camera control
Setup	Recording, schedule, system, storage, Time, PTZ, network, camera/TV setup
Network Upgrade	Remote network upgrade
Covert channel monitoring	Enable viewing covert channels on the network.

(1) Edit User Information

- ① Move to {Menu} {Setup} {System} {User Registration} {User Edition}.
- ② On the selection window, select a user using the arrow keys and the Select button.
- ③ On the user authorization setting window, select the user authorization using the arrow keys as shown below.



[Figure 6-44. User Authorization Setup Window]

(2) Add Users

- ① Move to {Menu} {Setup} {System} {User Registration} {User Addition}.
- ② On the user registration window, enter the ID and the password. (Up to four users can be registered. The user ID and password may contain up to 30 English letters.)
- ③ After entering the user ID and password, select the user authorization.

(3) Delete Users

- ① Move to {Menu} {Setup} {System} {User Registration} {User Delete}.
- ② On the selection window, select the user you want to delete using the arrow keys and the Select button.

1-5 0

-6 Admin. Password

- ① Move to {Menu} {Setup} {System} {5. Admin. Password}.
- ② On the password input window, enter a password using the numeric buttons of the remote controller or the arrow keys and the Select button. (the password can contain up to five digits.)

1-5 0

-7 Upgrade

The product can be easily upgraded through the use of an external storage device or a portable storage device with USB 2.0 port.

- ① Find and copy the upgrade file to the highest folder in the external storage device or portable storage device supporting USB 2.0.



1) When copying an upgrade file from the PC, delete the USB device properly from the PC and disconnect it from the USB port.

2) If the USB device is disconnected from the USB port while the upgrade file is being copied, the DVR system may not automatically detect the file.
3) Upgrading is impossible if the HDD is not mounted.

 Removing USB during the upgrade in progress may cause damage on the system.

- ② Connect the storage device with an upgrade file stored in the USB 2.0 port at Left/Right front panel.
- ③ Move to {Menu} ({Setup} ({System} ({6. Upgrade}.
- ④ Select **{Firmware}** and the upgrade file list stored in the selected device and simple version information for the selected file is then displayed as shown below.

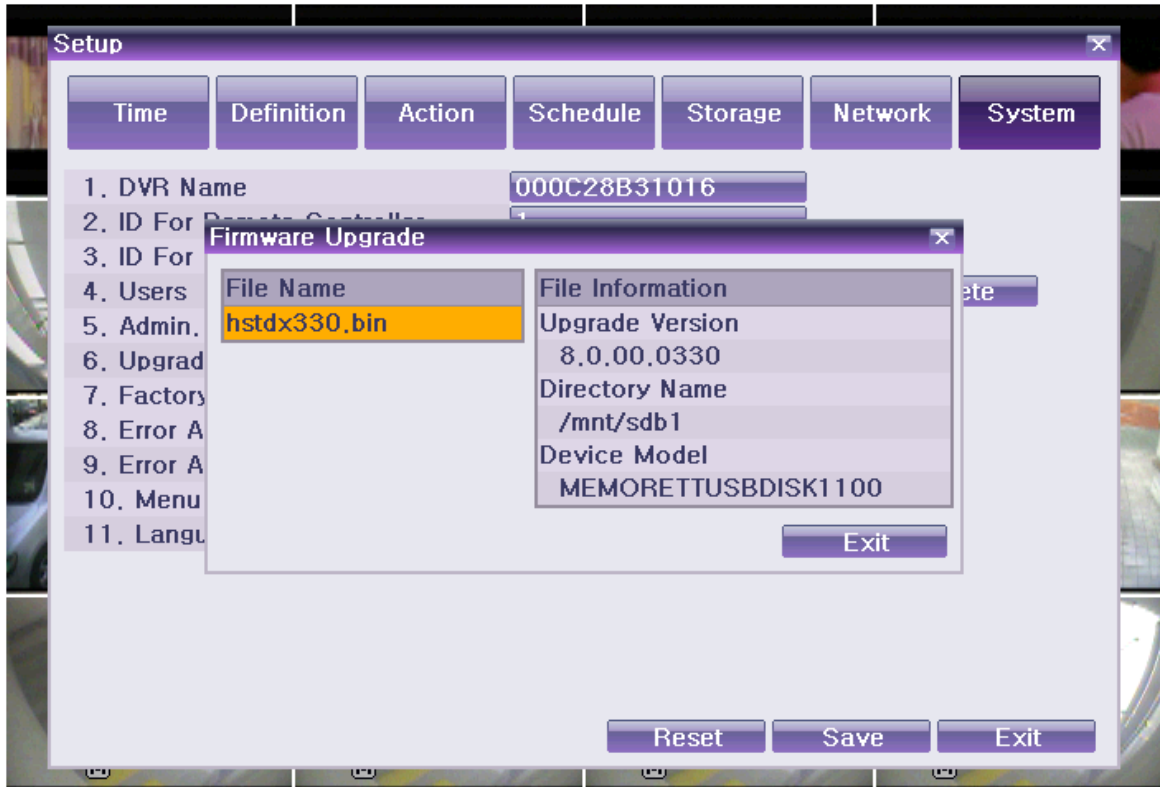

[Figure 6-45. Firmware Upgrade File List Window]

- ⑤ After selecting the file to be upgrade and a window shown below appears.

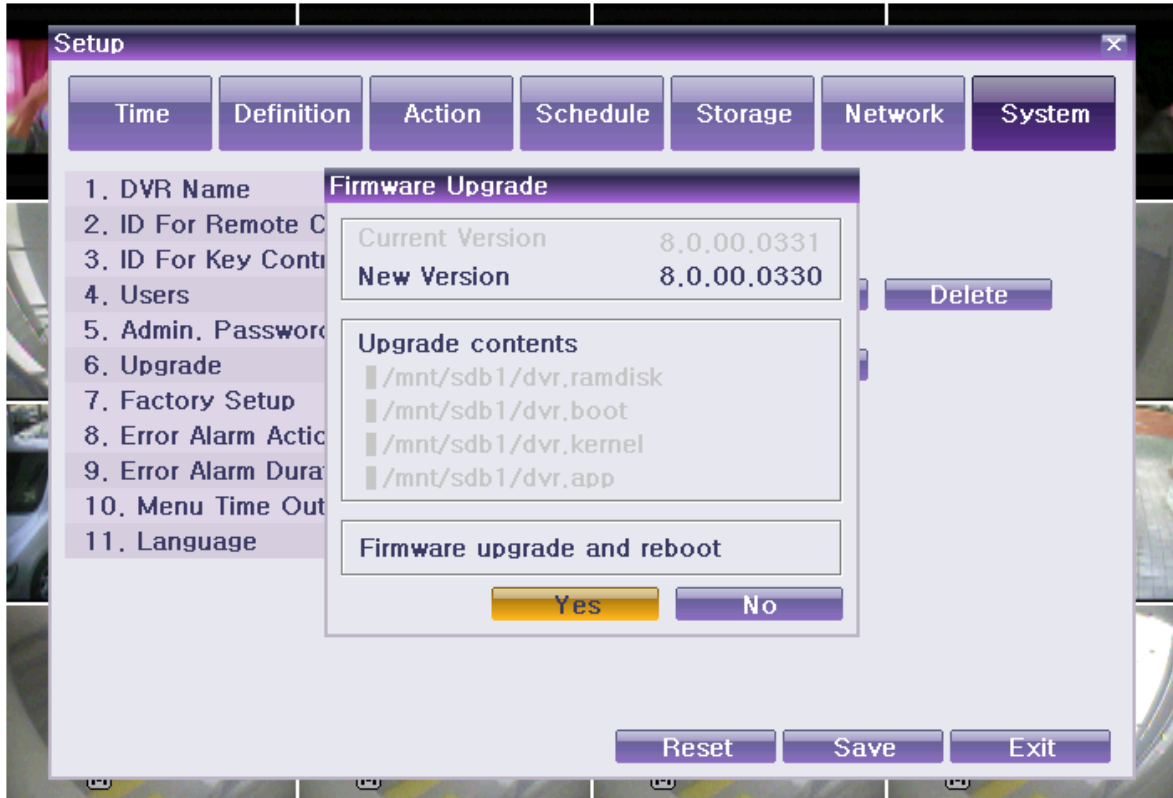

[Figure 6-46. Firmware Upgrade Progressing Window]

	<ul style="list-style-type: none"> ※ Downgrading to a previous version is not supported. ※ It is recommended that the DVR ID should be the same as the remote controller ID. ※ The upgrade information window will then appear within 15 seconds.
---	--

- ⑥ Read the information and select **{Yes}** to start the upgrade gradually. Select **{No}** to return to **{System}** mode.
- ⑦ After the update is completed, the system will be rebooted.
- ⑧ The system will automatically start. Upgrade is then completed.
- ⑨ Move to **{Menu} {Miscellaneous} {DVR Information} {3. Software Version}** to check the version.

	<ul style="list-style-type: none"> ※ All setup data are a fixed value in {Menu} {Setup} {System} {6. Upgrade} {Setup}.
---	--

1-5 0

-8 Factory Default

- ① Move to **{Menu} {Setup} {System} {7. Factory Setup}**.
- ② Select **{Yes}** when Initialization (Yes/No) Window appears.

	<ul style="list-style-type: none"> Note that all setting data will be initialized. ※ It goes back to Factory Default Value.
---	---

1-5 0

-9 RS232C Port

- ① Move to **{Menu} {Setup} {System} {8. RS232C Port}**.
- ② On the selection window, select the device using the arrow keys and the Select button.

1-5 0

-1 0 Alarm

Alarm is to notify system incidents [Video Signal loss/ HDD full/ FAN fail/ HDD fail/ HDD warning] to [Alarm/ E-mail/ Relay01/ System check].

- ① Move to {Menu} {Setup} {System} {9. Alarm}.
- ② Select [Alarm/E-mail/Relay01/System Check]. The user can select all by ticking as shown below.



[Figure 6-47. Alarm]

※ System Check

System Check is to pop up the System Check Window on the monitoring screen. It shows [Video Signal loss/ HDD full/ FAN fail/ HDD fail/ HDD warning].

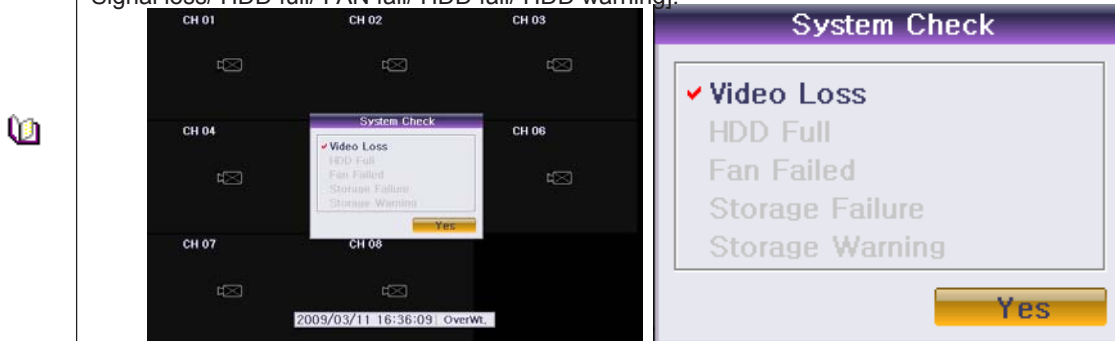

1-5 0

- 1 1 Alarm Setup

- ① It sets the duration of the alarm triggered by the recording and system event.
- ② Move to {Menu} {Setup} {System} {10. Alarm}.
- ③ In the selection window, set Alarm out time using the arrow keys and the Select button.

1-5 0

- 1 2 Menu Time Out

If no input is made in the System Setup menu using the front buttons, remote controller, or mouse, the system automatically shifts to real-time monitoring mode.

- ① Move to {Menu} ({Setup}) ({System}) ({11. Menu Time Out}).
- ② On the selection window, select the time zone you want to set using the arrow keys and the Select button.

Off	Automatic Menu Exit is not used. ※ The user can exit the menu by pressing the [ESC] button in the System menu.
1/2/3 MIN	If there is no input using the front button, remote controller, or mouse, the system will shift to real-time monitoring mode.
User Setup	The user can enter the time directly. ※ The time can be set to 1 ~ 60 minutes.

- ③ Selecting User Setup causes the input window to appear.
- ④ Enter the time using the numeric buttons or the arrow keys and the Select button.

1-5 0

- 1 3 Language

This feature is used to select the language for the On Screen Display (OSD) menu of the system. 17 languages are supported.

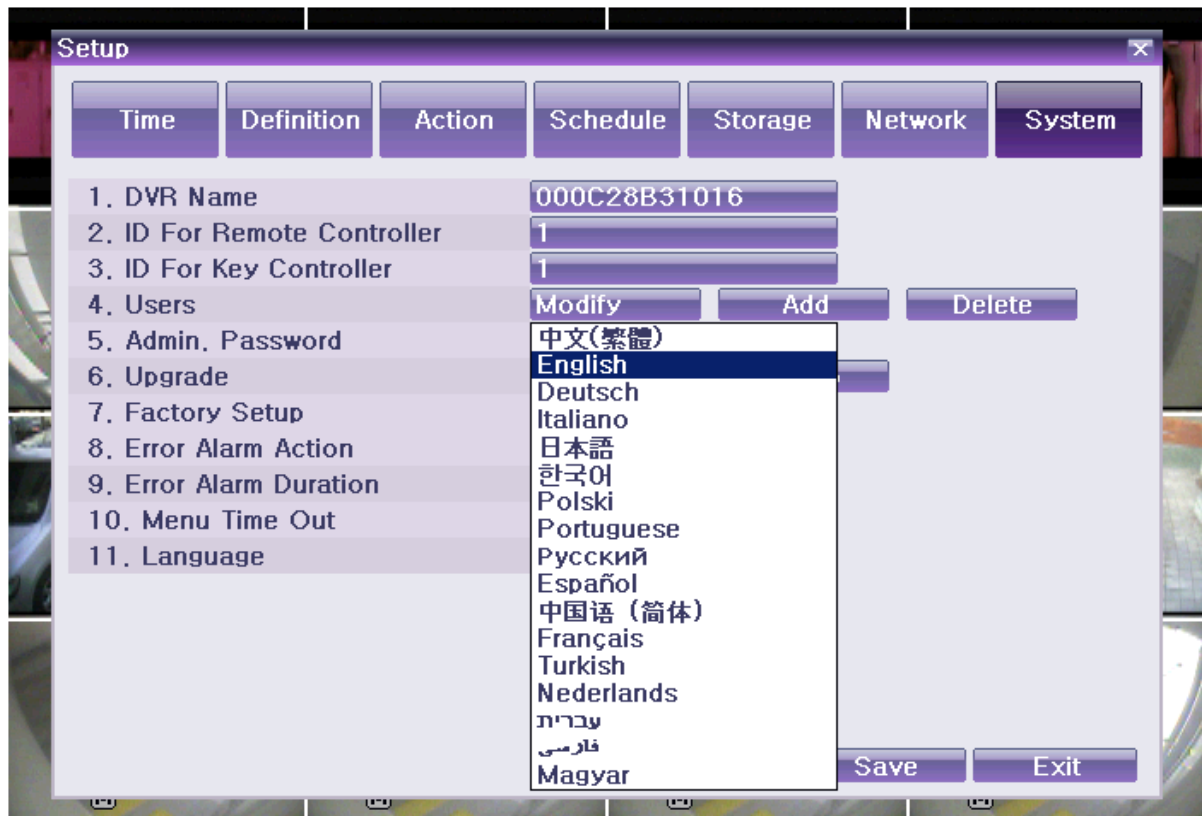

[Figure 6-48. Language Selection Window]

- ① Move to {Menu} {Setup} {System} {12. Language}.
- ② On the selection window, select the language using the arrow keys and the Select button.

APPENDIX

(1) Recommended HDD Specification



Type	Size	Capacity	Buffer	RPM
SATA I, II	3.5" 1, 2 Flat	Up to 1.5TB	over 8MB	over 7200

(2) Recommended PTZ Camera Protocol

NO	Vendor	Model	Protocol
1	A.D.	ULTRA_7	SENSORMATIC
		ULTRA_8	
2	CHOU	COHU3925	COHU
3	Dongyang	Dongyang	DRX-500
			DY-255
4	DYNACOLOR	DSCP	DSCP
5	EYE VIEW	EYE VIEW	EYE VIEW
6	FINE SYSTEM	CRR-1600i/s	CRR-1600i/s
7	GE	GE	GE_KARATEL
8	GSP	GSP	CYBERSCAN_1
9	HITRON	FASTRAX2	FASTRAX2
10	HONEYWELL	SCANDOME2	HSDN-251
11	LG	LG	LG_MULTIX,
			LG_OLD
12	MIKAMI	MIKAMI	MIKAMI
13	ORIENTAL	ORX-1000	ORX-1000
14	PANASONIC	WVCS854	WVCS854
15	PELCO	PELCO	PELCO – D
			PELCO - P
16	PHILIPS	PHILIPS	PHILIPS
17	PROLINE	PROLINE	PROLINE_UK
18	RIFATRON	RIFATRON-1	RIFATRON
19	SAMSUNG TECHWIN	SAMSUNG	SPD-1600
			SCC641
20	SUNJIN	SUNJIN	SUNJIN
21	VICON	VICON	VICON
22	YOKO	YOKO	YOKO

(3) Recommended USB2.0 Device

USB2.0 Device	Media	File System
Memory Stick	Flash Type	FAT32
2.5" Portable USB HDD	HDD Type	FAT32
CD	CD R, R/W	ISO9660
DVD	DVD +R, +R/W	ISO9660