

Advanced PTZ Controller

VIK-USB User's Manual



Chapter 1 Introduction

In This Manual

Overview: This manual covers the operation of the VIK-USB keyboard.

VIK-USB keyboard

This remote keyboard is an accessory for PTZ dome camera, etc
It allows the user to control from 1 to 255 camera.

Features

- Controls from 1~ 255 cameras.
- Multiple protocol supported in each channel
- RS485/RS-422 Communication (Tx : 3 port, Trx : 1 port)
- Programmable user preferences (preset, tour, group, etc)
- Built in 3 Axis proportional joystick
- Easy upload programmed data via serial communication port of PC.
- Built in 2 lines character LCD.
- User password support
- Designed for desktop use
- Programmable transmission speed for each IP (2.4~57.6kbps)

Note : units should be set to the communication protocol and the same baud rate.

Before installation

This keyboard system must be installed by qualified service and installation personnel.

Perform the following steps to install the keyboard system.

A. Unpack all components.

B. Place the keyboard in a convenient location.

Note : Carefully and completely read the manuals for each piece of equipment before attempting to installation and connect the equipment.

C. Decide on the configuration method.





D. Use one of the following sections to configure the wiring.



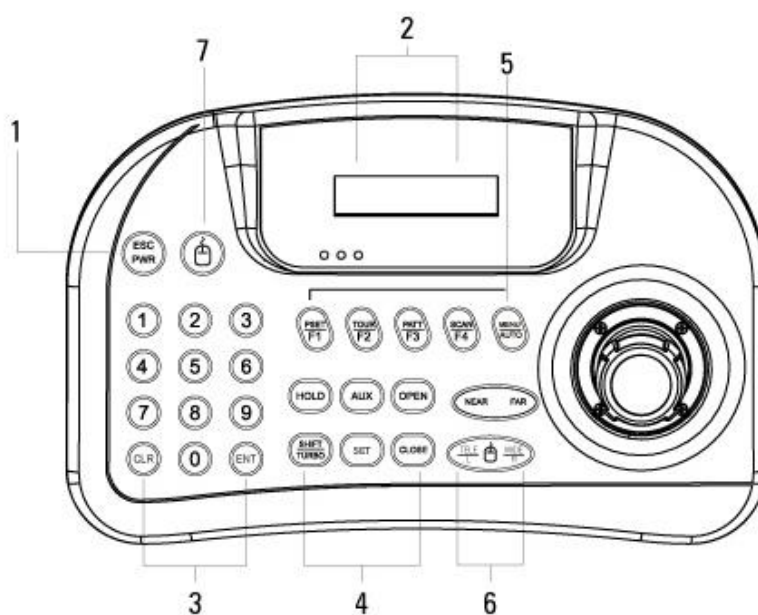

Chapter 1 Introduction

Hardware Overview



Hardware Components	This remote keyboard contains easy to use control keys on the front and simple input and output connectors on the back.
Control Buttons & connection	This unit provides the primary operator interface. Most operations are one or tow button presses. The following Table contains a description for each buttons on the keyboard and ort of cable connection. Use Figure 1 and Figure 2 as a reference

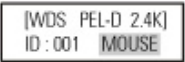

Number	Button	Description
1	ESC/ POWER 	Pressing the ESC/POWER button enters the power on/off or escape key. Right description led on(red). Pressing it again exits the Power off. (Push the  button 2-3 seconds) and then Power off)
2	LCD Display 16 x 2 Graphic display	Display Camera ID, Protocol, function status, general status, etc
3	Numbers	Camera ID setting value change, PTZ setup (1+ ), Main Setup (2+ )
4	Control Function Keys 	Hold : System locking (Unlocking : Input the password 4 digit ****) SHIFT/TURBO : SHIFT – Key for special function (Customize)/ TURBO-High Speed

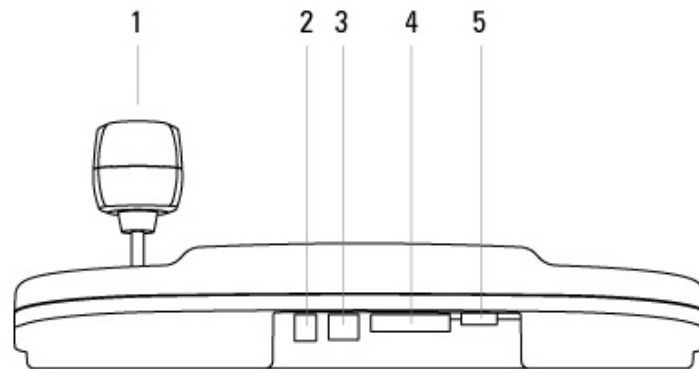
Number	Button	Description
5	Function keys 	F1 – MENU/AUTO : Function Keys (Preset, Tour, Pattern, Scan, Auto) MENU : Used for Camera(Pan/Tilt) Menu adjustment
6		Camera Focus Control
		Camera Zoom Control
7		MOUSE ON/OFF (Mouse Function Key 2-3 Seconds push) Mouse Character Description will be display 

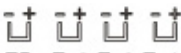

Number	Button	Description
1	Joystick 	Telemetry Joystick Blt allows precise control of Pan/Tilt/Zoom
2	DC 12V Input 	DC 12V Input, 140 mA
3	USB PORT 	Universal Serial Bus Port, USB Mouse function (External Equipment communication port)
4	RS-485  TRx Tx3 Tx2 Tx1	RS-485/RS-422 communications (Tx/Rx : 3 port, Trx :1 port)
5	Program	Download connector(For Program Update)

System Configuration and Wiring

Basic
Installation

Use the Keyboard Configuration when only one keyboard is connected to the controlled units. Connect the RS-485 output port of Remote keyboard to RS-485 input port of the first controlled unit using the terminal block.

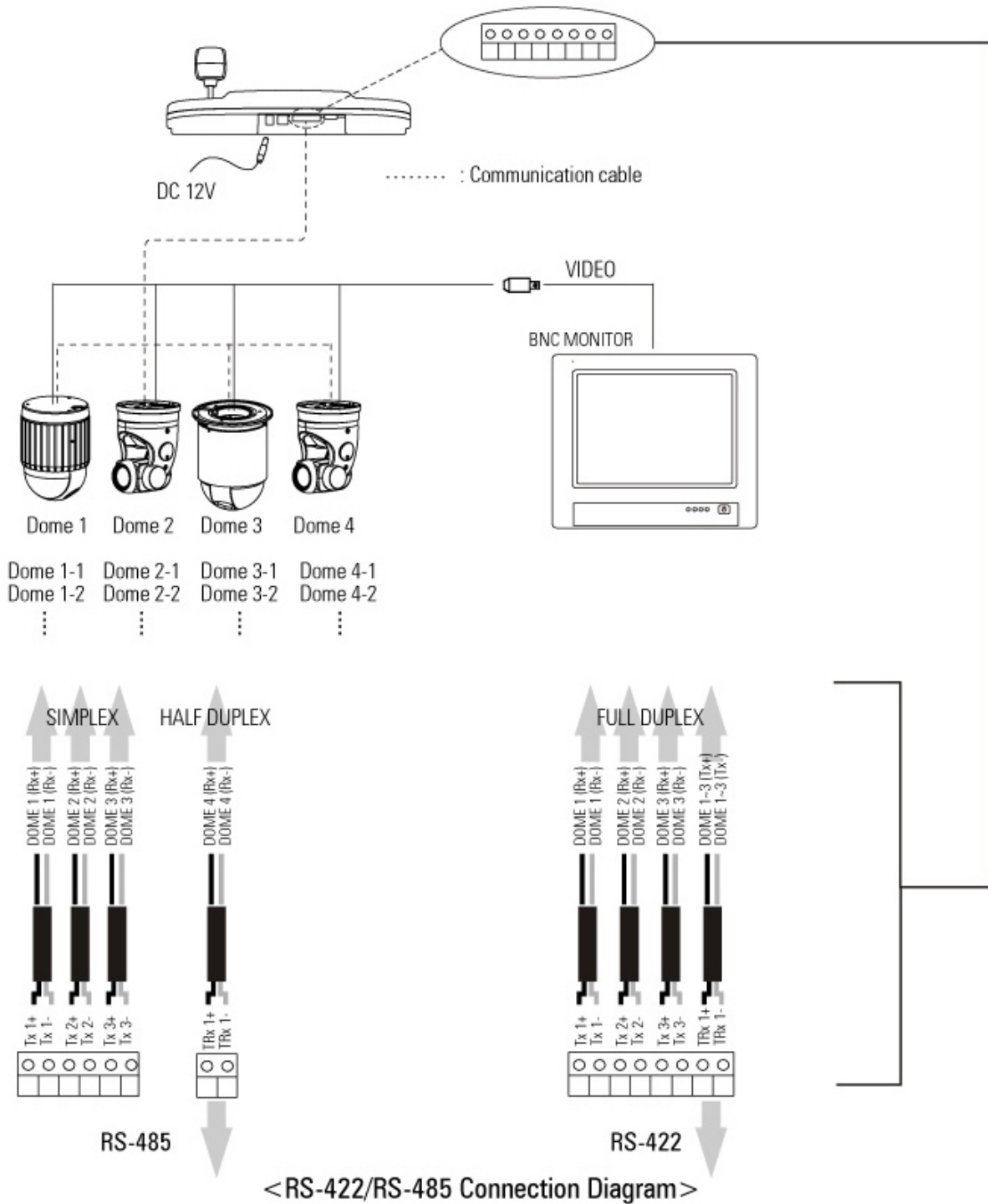

Chapter 2 System Installation & Typical Applications

System Installation

Keyboard Installation Before you start the keyboard equipment to your system, make sure the units to be controlled are completely installed and everything is working correctly. Before use of this keyboard, you should set the protocol and baud rate (2.4 ~ 57.6kbps) in the PTZ SETUP mode. Use the following steps to set the communication protocol and baud rate.

PTZ setup

PTZ setup PTZ Setup mode, select 1 + , (2~3 seconds)
Setup screen allows you to make change each programmable clause.
Note : The baud rate must be the same between the controlled unit and the keyboard.

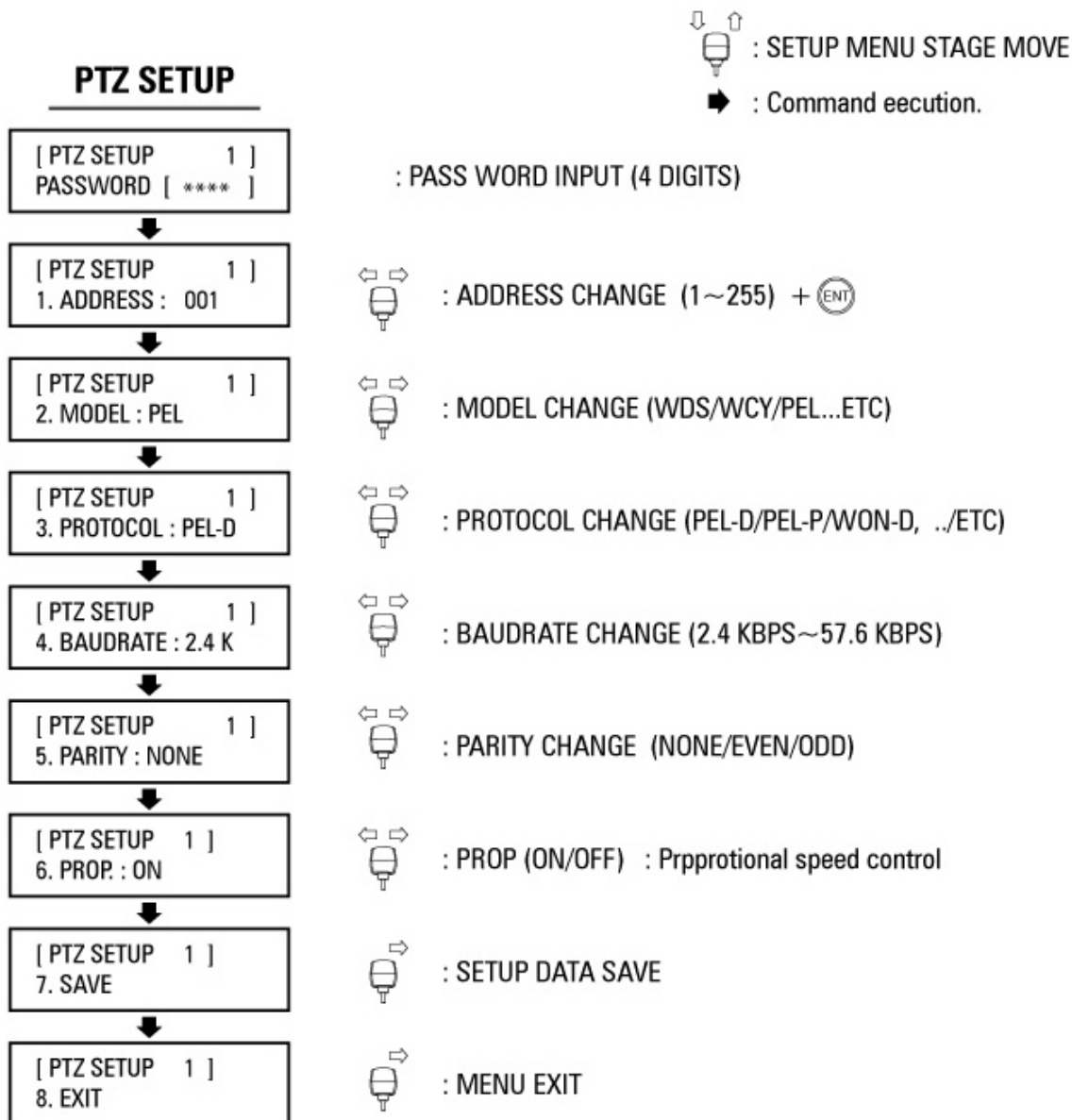

Main Setup

Main Setup

Main Setup mode, Select 2 + , (2~3 seconds)

Setup screen allows you to make change each programmable clause.

Note: The baud rate must be the same between the controlled unit and the keyboard.

MAIN SETUP

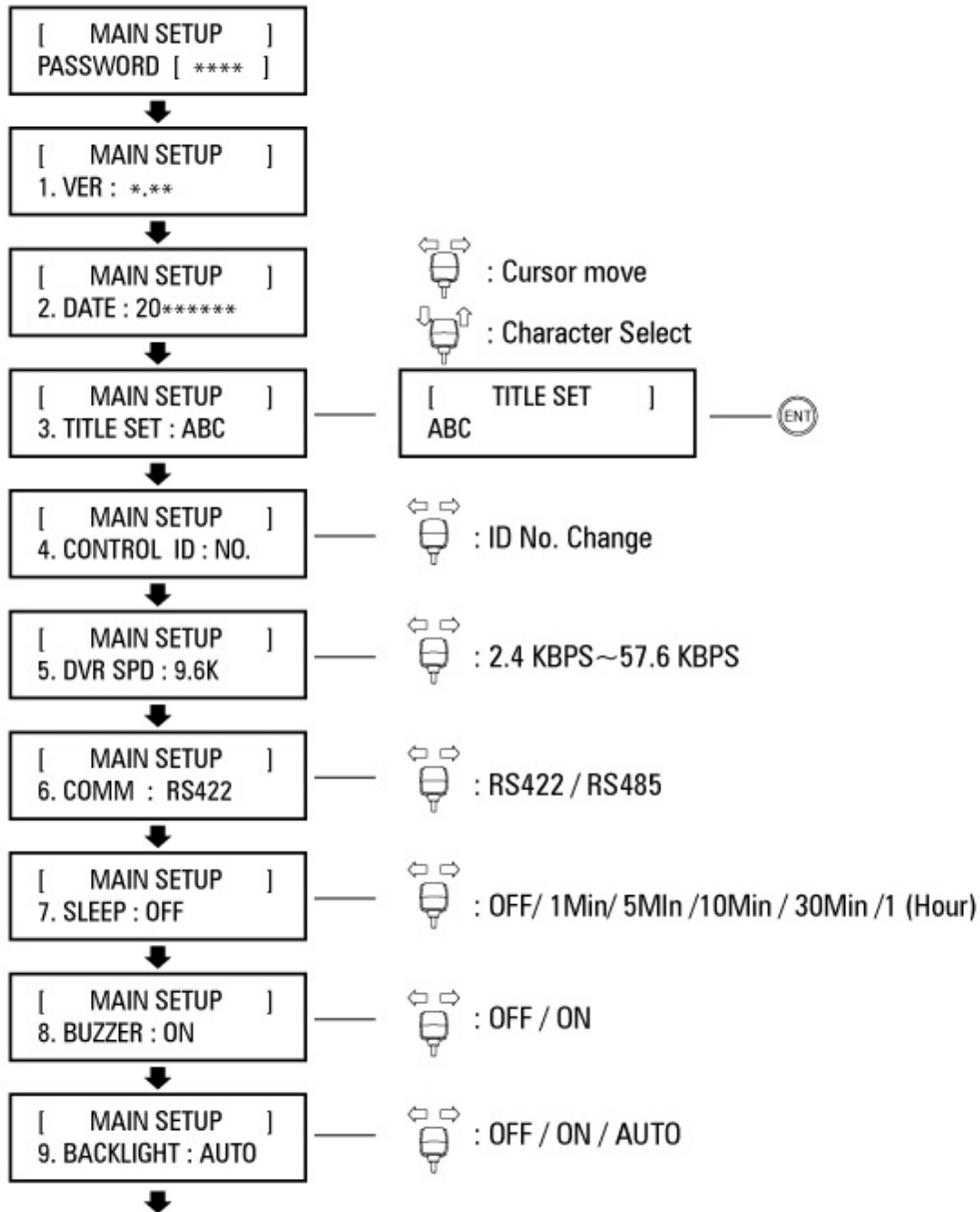

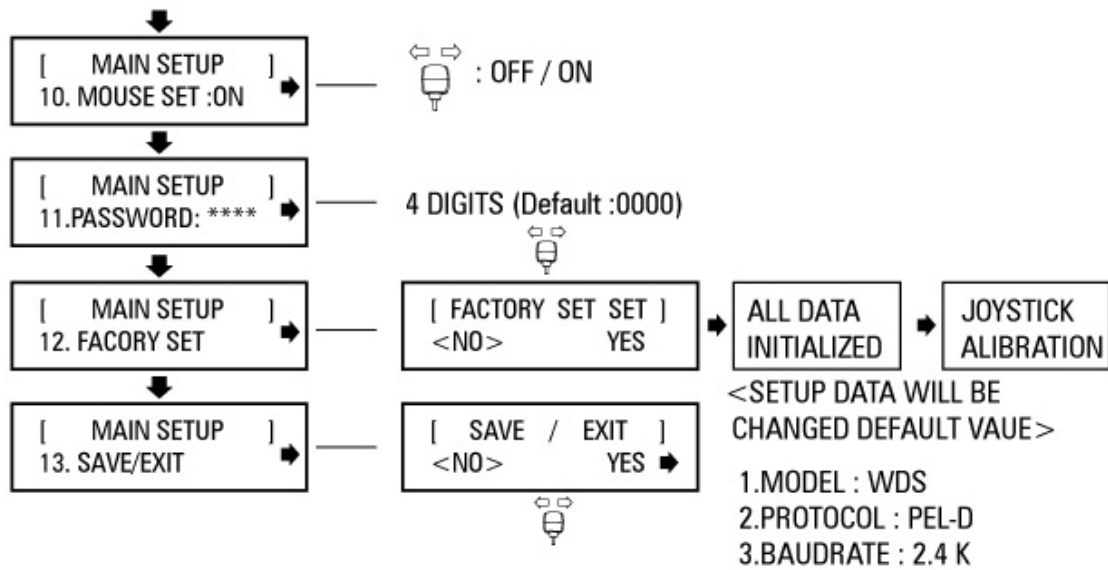

Joystick Calibration

It is for the keyboard to set the Max. movement of joystick.



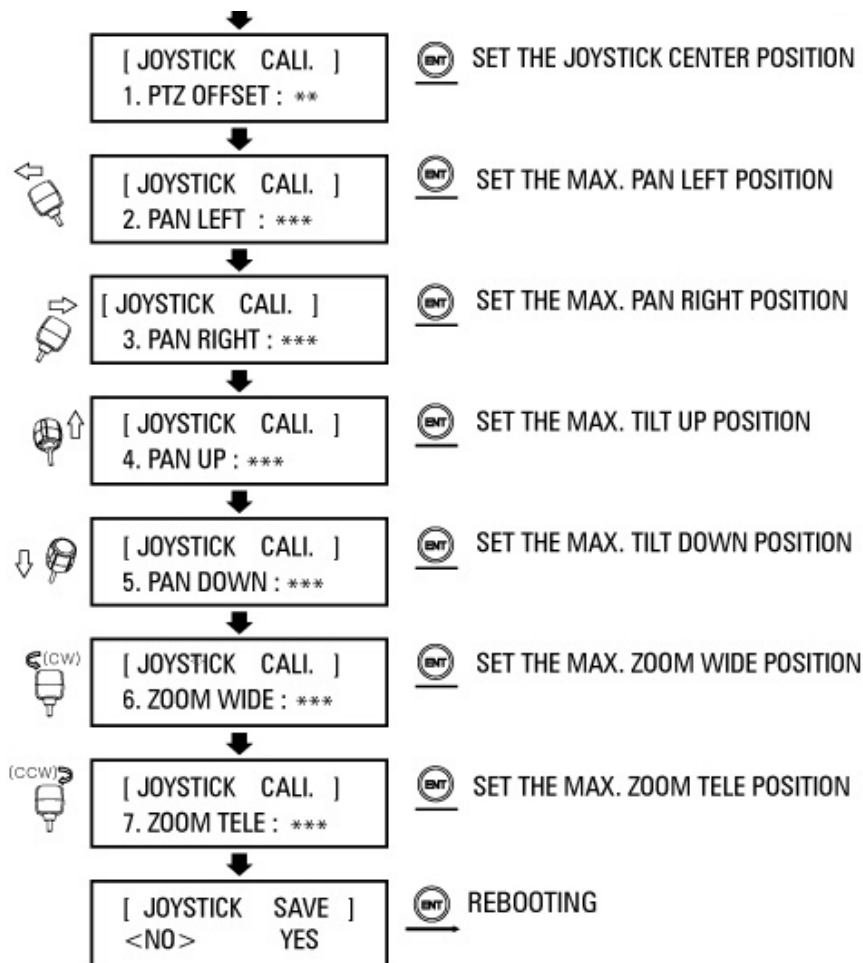

Calibration method : Joystick move {Position Value} +







Easy Setting Function {E.S.F}

Easy Setting Function (Number key + Function key)
 Number key + PSET/TOUR/PATT/SCAN/E.S.F
 Is current position data(pan, tilt, focus, zoom data) save or call Dome memory

DATA SAVE (SET)

-  +  (PSET button 2 seconds push) ➡ Current Position Saved Preset No 2
-  +  (TOUR button 2 seconds push) ➡ TOUR MENU CALL OF DOME

DATA CALL (GOTO)

-  +  (PSET button push) ➡ No 2 Preset position execution
-  +  (TOUR button push) ➡ No 3 TOUR Execution of DOME

Specifications	
Model	WTX – 1200A
Keyboard Communication	Interface : RS – 485 (Tx 3 port, Trx 1 port) P
	An/Tilt operating distance : 4700 ft(1029m) No 24 AWG wire
	Protocol : Multiple (Pelco-D, etc), (Baud rate selectable)
Connector Type Data	TERMINAL BLACK (8P)
Keyboard Keypad	Rubber button
	Numeric keypad and camera function key
Joystick	Stick 3-axis, variable speed with zoom
Input Voltage	12V DC or 9V batt (battery mode)
Power Consumption	Max. 140mA
LCD Display	Graphic display : 16 * 2 Graphic display
Operation Temperature	0 to 45
Humidity	10% - 70% non-condensing
Dimension & Weight	280(W) x 174(D) x 92(H), Net: 0.7 kg Gross: 1.7 kg
Packing include	WTX – 1200A keyboard, Adaptor
	Packing include : Batt 9V, USB cable, Manual, Terminal Block (8p)

3015 Eagle Drive, Suite 100, Grand Prairie, Texas 75052
Local Number: (214) 635-4855 / Fax: (214) 988-2858
sales@veilux.net
www.veilux.net